

## Voice and Personality—A Broadcasting Experiment.



The Journal of the British Broadcasting Corporation.

Vol. 14. No. 172. [Registered at the G.P.O. as a Newspaper.]

JANUARY 14, 1927.

Every Friday. Two Pence.

## The Arm-chair Millennium.

By ROSE MACAULAY.

**A** BRIGHT millennium (why do we thus limit our expected felicities to periods of a thousand years?) seems to be rapidly approaching. It is to be a millennium of comfort and ease; an arm-chair millennium.

What preachers have, for the last several centuries, called 'this age of hurry and unrest' is drawing to a close. Already we need not leave our happy homes in order to hear music, for we have music pouring into our sitting rooms, bedrooms, or wherever we elect to hear it. No more, either, need we go out to dance, for dance music fills our passages and parlours and we can Charleston round the dining-room anyhow until midnight.

Nor is it necessary to sally forth in search of oratory (if we chance to have a taste for this pleasure), for ever and anon, and quite often enough to suit most of us, the sonorous voices of eloquent speakers declaim into our drawing-rooms. Nor need Sunday evening services any more be attended in person, for those of us who have a fancy for these can join in prayers, hymns, psalms and sermons sitting on our own sofas. Many persons, indeed, do this who never dreamed, nor ever would dream, of being found within a church.

As to the drama, the arrangements for its transmission to an arm-chair audience are not yet completed; at present they can only hear it, which is unsatisfactory, if economical and comfortable; but one understands that before long television will give us quite a good view of the stage and performers. That, for many of us, will be the millennium. To see and hear a play every night, without further trouble and expense than one's own wireless set entails, without

the tedium of going out and coming back and the discomfort of being surrounded by other people as noisy and tiresome as ourselves (for those in our homes we should be able, with a little firmness, to keep in order)—here indeed is bliss, only a little marred by the fact that we cannot choose what play we see, but must accept what is



Miss ROSE MACAULAY.

Miss ROSE MACAULAY, well-known journalist and author of witty and shrewdly satirical novels, amongst which listeners will recall 'Potterism,' 'Orphan Island' and 'Crewe Train,' is here to be found among the prophets—in none too serious a vein.

given us. And, if our taste is rather for the Silent Drama, we shall doubtless be able soon to behold that too, captions and all.

All the same, we shall not even then have

attained perfect convenience. There will still be life to be lived, and I, for one, feel strongly that we ought not to have the trouble of living it. *Everything* ought to be done for us by what is, oddly enough, called wireless, and what I, observing the tangle, as of nests of vipers, which crawls profusely about my own set and runs down my passage, prefer to call wires.

Yes; everything should be done for us; why not? It is rumoured that we may soon have rushing into our homes over the wires all kinds of domestic help; unseen power will come at our need, and will clean our rooms, wash our dishes, cook our food, run up meals to our arm-chairs on electrically propelled tables, make our beds, turn on our baths, divest us of our clothes and dress us again, shave us, wash us, do our hair, fling us into bed.

And as to our recreations, why should we not have dinner parties by wireless of an evening, instead of sallying out from our homes to the homes of others? Turn us on to any dinner party where there is jollity, wit, the feast of reason and the flow of soul, transmic to us the taste of savoury viands (this should be a simple business) and let us sit and enjoy the evening without trouble.

It may be objected that, if everyone thus sat at home, there would be no dinner parties to be broadcast to them, but to provide these should, of course, be the task of the staff at Savoy Hill. As for the public-houses, they may as well, when these arrangements are completed, close down, for every sensation they provide of liquor imbibed will be conveyed to us, and even, if desired, the sensation of having imbibed too much.

(Continued overleaf.)

S

## Lectures by Wireless.

### A Glance at the New Syllabus of Talks.



Prof. C. H. REILLY.

FROM its inception four years ago the British Broadcasting Company held that its duty was to provide listeners not only with light entertainment, but also with recreation in the widest sense of the term. It was realized that the 'fired business man' and the weary manual labourer did

not want only jazz music or comic songs, excellent though these might be in right proportion and at the right time, and it was realized too that thousands of listeners, young and old and in all walks of life, were ready and eager to enjoy the great musicians, and the great speakers and teachers.

During the past few years, therefore, talks on many subjects of general interest have been fitted into the ordinary programme. These talks may not have pleased everyone, but they have undoubtedly stimulated and attracted a very large body of listeners. This policy is one which the new Corporation intends to follow as closely as did the old Company.

Many listeners are now beginning to ask for something more. There is a growing demand for talks that are more definitely educational. Listeners are asking for information about the developments of modern science, literature and philosophy. These enquiries are coming from the many thoughtful men and women who have grown up without a chance of knowing some of the fundamental truths about the world we live in, and about the laws that govern our minds and our bodies, and the arts of music, poetry and painting.

Even within the bounds of the present general programme it is possible, by a slight re-arrangement of timing, to provide this service without giving any less in the way of entertainment to those who declare that they do not like 'talks.'

Here are some of the outstanding features of the Talks' programme for the coming weeks.

Beginning on January 17, a new weekly series of the more definitely educational type will be given each evening from Monday to Friday, from 7.25 to 7.45. Mondays will be devoted to fortnightly talks in French and Spanish by M. Stéphan and Mr. Bletcher; Tuesdays and Thursdays will be devoted to courses specially designed for groups of listeners who may want to meet regularly under a group leader, and to follow the talk by a discussion. Wednesdays and Fridays will be devoted to similar series, treated in a slightly less instructional manner.



Prof. V. H. MOTTRAM.

Professor Philip J. Noel Baker, who will speak on Tuesdays in the first half of the term on 'Foreign Affairs and How They Affect Us,' is Professor of International Relations in the University of London—and an Olympic Games athlete besides. Mr. Edward Cressy, who will follow

Professor Baker in the second half of the term on 'The Growth of Industry,' is already well known to listeners by his course on 'The Engineer in Adventure.' Scotland is arranging a course of its own on 'Scotland's Industrial Story,' by Mr. Arthur Birnie, of Edinburgh University, to take the place of Mr. Cressy's series. On Wednesdays, Professor V. H. Mottram will give a course on 'Present Day Problems of Food,' followed, in March, by Principal

Grant Robertson, of Birmingham University, on 'Empire Builders,' a series of biographical sketches of six historic figures. On Thursdays, Mr. R. R. Marett, Reader in Social Anthropology in Oxford University, will give a course on 'The Making of Man,' which promises to be a particularly interesting series on the beginnings of law, marriage, religion and the other foundations of human society. Mr. Marett will be followed in the latter half of the term by Mr. W. P. Pycraft, of the Natural History Museum in South Kensington, on 'Nature's Camouflage,' a series of talks on the coloration of animals. On Fridays, Professor C. H. Reilly, the head of the famous School of Architecture at the University of Liverpool, will give six weekly talks on 'Some Modern Buildings,' in conjunction with a course planned by the National Home Reading Union, and after him Professor Charlton, of Manchester, will give five talks on 'Poetry and the Plain Man.'

In addition to the above, there will be a double course on Wednesday afternoons at 3.45, planned in consultation with the National Federation of Women's Institutes, and designed to be of special interest to countrywomen. Beginning on January 19, Miss Rhoda Power will give six talks on 'Village Life in Olden Times,' and on March 2 Mrs. K. W. McIver will begin a series on 'Citizenship in Practice.'



Mr. EDWARD CRESSY.

Organizations engaged in any kind of adult education, such as working men's clubs, tutorial classes, the Y.M.C.A. and Y.W.C.A., etc., which can promote the formation of groups of their members to listen and discuss these talks, may like to know that certain of the lecturers are being asked to prepare short notes which will be issued for the use of group leaders, to help them to steer the discussions. Lists of books recommended for further study will also be printed in the Syllabus of Talks, which can be had free on application to the B.B.C., Savoy Hill, W.C.2.

(Continued from column 3.)

advent of the arm-chair millennium; they should each pair with some society of opposed tendencies, as do Members of Parliament on opposite sides of the House. Thus, the Anti-Vivisection Society should pair with the Society for Anatomical Research, the Vegetarians' Guild with the Butchers' Union, the Birth Controllers with the More Men for the Empire League, Fascists with Socialists, the Miners' Federation with the Coal Owners' Association; and the newspapers might do a little pairing too; and as to that, and while we are on the subject of pairing, and not wishing to be in the least offensive, what about a little of it among private persons? We all know some people who would be better paired than actively functioning; perhaps most of us would.

But here we are on delicate and controversial ground. This paper started with an exaltation of the marvels of science and the pleasures of inactivity, and an exhortation to keep both of these going, only more so; let it end on the same note—that of perfect peace.

## The Arm-chair Millennium.

(Continued from the previous page.)

But broadcasting will have to become also more selective; each set owner must be able to call for what he wants and get it; he will set his wavelength for a Scotch and splash, or a small lager, or a large raspberry syrup, without necessarily inflicting these beverages on others.

Indeed, this matter of individual selection is the most important of the points which the broadcasting authorities must see to. In a world with so many million different tastes and desires, it is not to be expected that we should all want to see and hear the same things. At present there is nearly always someone in each home ready to say 'turn that nonsense off' just when the others are enjoying themselves. There is no reason why one listener should not enjoy 'Who's my Baby?' while others listen to Bach, Debussy, or Sir Oliver Lodge on the atom.

IN the millennium, those of us who have a whim to see a little country landscape, without the trouble of taking a walk or a journey, will be shown vignettes of fields, woods and lanes which would cause others to expire of boredom. Those who wish to do so will be able to enjoy country scenery without the tedium of 'living in Kent and being content,' or of 'going to Surrey and living without worry,' while those more urban souls who find the home and other counties distasteful, and prefer Art to Nature, will instead look at picture exhibitions from their chairs (but Heaven forbid that those who lack this taste should have to do so).

And for those with a taste for literature there will be reading aloud of infinite variety, so that never again need we trouble to wear out our eyes by studying print. As to those of us who desire to write, the gift of words will rush into us along the wires, and we shall be electrically impelled to fluency, if not to intelligence. Our pens will be propelled over the paper as if planchette pushed them, and page after page will rapidly be filled with dashing electric thoughts.

I should like all this to occur. I hold that there has always been too much action and initiative in this world where all things travail together. We have made of it a restless, untranquil place, in which created beings, human and other, hurtle about from spot to spot, hectically intent on their private ends. Why, for instance, go forth to see doctors, dentists, osteopaths, and other healers, when the same treatment could be so much more restfully meted out to us as we sit at home? We should be able to press a button and be—well, not healed, for to heal human ills is usually beyond the skill either of human or electrical physicians, and can only be done by the processes of time—but anyhow, treated.

I contemplate starting a Society for Not Taking Any Trouble. Most societies seem rather to have been started with some other end in view than this; it is quite time that mine got going. As to most of the societies now functioning, a short and convenient way with them has been suggested, which would suspend their activities and hasten the

(Continued in previous column.)

# London and Daventry News and Notes.

THE reorganization and expansion of the broadcast news service which came into operation at the beginning of the present month, in addition to advancing the times for transmitting the bulletins—in itself a boon to those who live in scattered parts where evening newspapers do not circulate—has also enabled considerable and important re-timings, which were hitherto impossible, to be effected in the programmes. These re-timings are naturally reflected throughout the whole programme of the evening, and opportunity has been taken to recast the character of the transmissions in the light of what correspondence from listeners has shown to be the general demand. Sufficient time has now elapsed since the change was introduced for the new ideas to take definite shape, and for the guidance of listeners it may be well to set out in detail the principle on which programme-building will proceed until further notice.

- 6.30.—Weather and first news bulletin.
  - 6.45.—Musical interlude or London Radio Dance Band.
  - 7.0.—First evening talk.
  - 7.15.—Pianoforte interlude.
  - 7.25.—Second evening talk.
  - 7.45.—First evening concert, usually of the popular or lighter kind—variety items, concert parties, music, etc.
  - 8.45.—Pianoforte or song recital.
  - 9.0.—Weather forecast, second news bulletin, and local announcements.
  - 9.15.—Third evening talk. This will be of a distinctly greater programme value than hitherto, special topical subjects being dealt with by authoritative speakers. As time goes on these will be supplemented by specially-arranged 'outside broadcasts.'
  - 9.30.—Second evening concert, usually of the more serious or 'heavier' kind. This will continue until 10.30 on three evenings each week, when dance music is relayed; and on the remaining evenings until 11 p.m.
- The Sunday afternoon and evening programme timings remain as at present, but, as already mentioned in *The Radio Times*, the Saturday afternoon concerts are being considerably strengthened.

Mr Flotsam and Mr. Jetsam, the original and versatile entertainers at the piano, whose musical 'news bulletins' proved so enjoyable a short time ago, are giving a series of similar items in the programmes during the week beginning Monday, February 7. Each evening, until the following Saturday, they will appear for a quarter of an hour, but in order to give all listeners an opportunity of hearing them, the time will not be fixed, as was done previously, but will be varied each evening so as to cover the period between 8 and 10.15 p.m.

So that listeners shall obtain the fullest enjoyment from the performance of *The Red Pen*, described by its author—A. P. Herbert of *Punch*—as 'a sort of opera; a libretto is being prepared and will be available in good time for the transmission at 9.30 on Monday, February 7, when Mr. Geoffrey Toye, the composer, will conduct. The earlier concert during the same evening will consist of three-quarters of an hour of variety items, including some character readings from Dickens.

The Seventh National Concert at the Royal Albert Hall on Thursday, February 3, will be conducted by one of the most distinguished of young German musicians, Hermann Scherchen, who is now the permanent conductor of the Frankfurt Museum Concerts. His attainments are doubly interesting, in that he is a self-taught musician, beginning as a viola player in one of the leading Berlin orchestras, and in the course of only four or five years working his way to the position of conductor of the Symphony Orchestra, Riga. Following his release from Russia, where during the war he was imprisoned, he founded and conducted in 1918 the New Music Society of Berlin. He is one

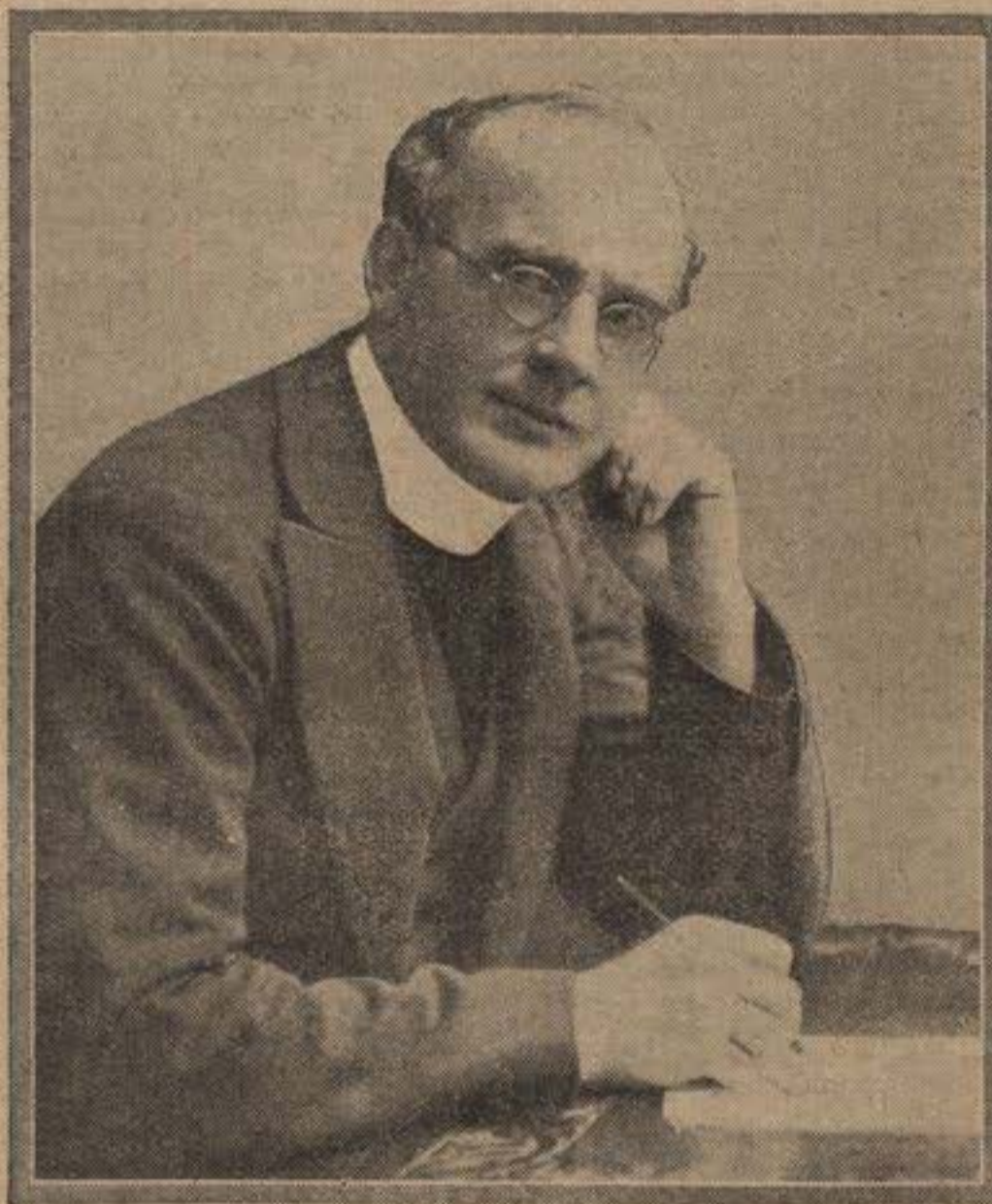

THE NEW VICAR OF ST. MARTIN-IN-THE-FIELDS.

The Rev. W. P. G. McCormick, who is coming to take the place of the Rev. H. R. L. Sheppard at St. Martin's, will be welcomed by listeners everywhere when he steps into the pulpit made so famous by his beloved predecessor.

of the most energetic pioneers of new musical styles, and his programme on February 3 will include a string sextet, *Verklärte Nacht*, by Arnold Schouberg, arranged by the composer for string orchestra. This work should sound remarkably well with the large body of string players (over one-hundred) in the National Orchestra. Another important work in the programme will be the *Eroica Symphony* by Beethoven, to which the centenary commemoration of Beethoven's death in March will lend added interest. The soloist in the programme will be Sturbi, the Spanish pianist.

Those who like popular orchestral music will find all they require in the programmes on Friday evening, February 11, and on the following afternoon, when Mr. John Ansell is to conduct the Wireless Orchestra. The Friday evening programme will also contain a performance by a special Radio Concert Party, now in course of formation, as well as an outside broadcast from one of the London theatres.

A new revue by L. du Garde Peach, of *Punch*, will be given from the London Station between 7.45 and 8.45 p.m. on Saturday, February 12. The author has written many of the most successful little radio plays, such as *Light and Shade*, which have already been broadcast, and he has now prepared what he terms 'an historical revue,' in which will be found an entertainment of an unusual type. The music will be by various composers.

Some forthcoming variety items:—

WEDNESDAY, JAN. 26.—The Indefinites Concert Party, consisting of Charles Clapham, Billy Dwyer, Jack Rickards, Cecil Harrington, George Thomas and Fred Lewis. This organization, described as 'an original concert party,' will give a programme consisting of many interruptions, such as one might expect from Clapham and Dwyer.

THURSDAY, JAN. 27.—The Gresham Singers.

Miss Elspeth Douglas Reid in character studies, and her first broadcast appearance.

FRIDAY, JAN. 28.—Eddie Sheldon, syncopated numbers.

Ramon and Nada in a musical act. Rickards and Stevens, cross-talk comedians.

MONDAY, JAN. 31.—Wish Wynne, character comedian.

Tom Clare, at the piano.

Will Kings, entertainer.

Tubby Edlin, comedian, in his first broadcast, which will probably include a burlesque news bulletin.

A short programme will be broadcast on Wednesday, February 9, which will include a number of orchestral works by the composer Alonso Lopez, in his own country—Spain—a successful composer of musical comedy. Further details of the Spanish artists and conductor for this programme will be published in our next issue.

Puccini's opera *Le Villi*, or *The Night Dancer*, will be relayed from Glasgow through London and other stations on Thursday, February 10. It was Puccini's first opera, and is really a fairy story, the main theme being the refusal by a mortal of the love of an immortal and the woeful consequence which ensued.

The most important work by the great English composer, Henry Purcell, apart from his *Dido and Aeneas*, is his so-called opera *King Arthur*, in which he was associated with Dryden (1691). The music is most accurately described as incidental music to the play. A concert performance is to be given at Birmingham on Saturday, February 12, under Mr. Joseph Lewis's direction, and this will be relayed through Daventry.

Such is the popularity of syncopated music that it is not now sufficient for any good dance band merely to play something about Mary, her Pa and Ma, and the house where the Charleston is always being danced. Of these important persons and things we must also sing. Accordingly, the London Radio Dance Band is to have a fox-trot singer, Eddie Sheldon, who will add to the studio entertainments from time to time.

# News From the Provinces.

## MANCHESTER.

IN no way is Manchester's love of music so clearly shown as in the continued success of the Tuesday Midday Society's concerts, when for three-quarters of an hour many business men forget their worries and anxieties and give themselves up wholeheartedly to the enjoyment of good music. Many prominent artists have appeared at these concerts, which were originated during the war to raise money in aid of the Second General Western Hospital's Entertainments Scheme. The concerts were so successful that there was enough money to pay the expenses of the hundred voluntary concert parties which toured the Red Cross and Military Hospitals, bringing brightness into the lives of the wounded. Many of these concert parties were organized by Mr. Edward Isaacs, who is to-day Director of the Tuesday Midday Concerts Society, formed in response to the general demand for the continuation of the concerts after the war. For more than a year, nearly all these concerts have been broadcast by the Manchester Station, and a particularly interesting one takes place on January 25, when the famous Brodsky Quartet will make another of its periodic appearances.

A short recital will be given by Mr. Leonard Hirsch at 9.30 on Thursday, January 27. Mr. Hirsch is a member of the Hallé Orchestra and of the Catterall Quartet.

A novel programme under the title of 'When Greek Meets Greek,' is being given on Saturday, January 29. It takes the form of a competition in humour between representatives of England, Ireland, Scotland and Wales, well-known entertainers championing the humour peculiar to their own countries.

*Till Eulenspiegel*, one of Strauss' most popular works, and Smetana's beautiful tone poem, *Vltava*, will be included in the programme on Sunday afternoon, January 23. The whole concert, with the exception of vocal interludes by Mr. Robert Burnett (baritone), will be devoted to the interpretation of tone poems by such masters as Strauss, Smetana, Tchaikovsky, and Saint-Saëns, played by the Station Augmented Orchestra, under the conductorship of Mr. T. H. Morrison.

## BOURNEMOUTH.

THE Yeovil Town Silver Prize Band, who will be heard from the studio on Thursday evening, January 27, are winners of many laurels. Last year they took second prize in their section at the Crystal Palace, when twenty-four bands from all parts of the country competed. In addition to various other cups and shields, they gained the distinction of carrying off the Somerset County Championship in 1926, on the first occasion when this competition was held. The Musical Director of the Band, Mr. R. W. Davison, who will be heard in a cornet solo, is a gold medallist, and was formerly a member of the famous St. Hilda's Colliery Band.

For the classical programme later in the same evening, Miss Winifred Small will play, among other things, Bach's *Violin Concerto in E Major*.

The talk for farmers on Tuesday, January 25, will be of special interest, as the speaker, Mr. Colin D. Ross, is the Agricultural Organizer for Devon.

## CARDIFF.

WHILE a Welsh evening programme brings a big demand for old favourites, it is becoming increasingly apparent that there is a dearth of Welsh composers who use what might be called the native idiom. Wales produces composers of international fame, but they do not often enrich their national treasury of song. Cardiff Station is searching for young composers of talent, and gives sympathetic consideration to the work of unknown writers in the Principality who have something new to say.

A novel feature, entitled 'A Hidden Programme,' will be given on Saturday, February 5. The whole programme will illustrate a well-known song, and each item will supply a clue. Although, in one sense, it will be rather like a charade or hidden name competition, this is the less important aspect of it. The other aspect is that the central idea of the title will be enriched by each separate item, and the cumulative effect should be very strong.

Most of the English-Welsh plays broadcast from Cardiff Station have been given an urban setting. Even when the mind picture is of a village, the action often takes place in a miner's kitchen or a shop back-parlour. A new Welsh play, *Elias and the Mushrooms*, which will shortly be broadcast, will take listeners away from the 'jumbled heap of murky buildings' into the bracing winds that sweep across the hills behind Penmaenmawr in North Wales.

A performance of Sir Frederic Cowen's *The Water Lily*, will be given on Sunday, January 30. This work was first produced at the Norwich Festival of 1893, and is of particular interest to West Country listeners, as Wordsworth's 'Egyptian Maid' is the source of the libretto. It tells of a wrecked maiden who was conveyed to the Court of King Arthur by means of enchantment and lay in a trance until a pure knight awakened her. The Station Symphony Orchestra and the Station Choir will take part, and amongst the soloists will be Miss Sybil Maden, Mr. Roy Henderson, and Mr. Hubert Carter.

## LIVERPOOL.

THE Roman Catholic Archbishop of Liverpool, the Most Rev. Frederick William Keating, D.D., will give the address at the Religious Service to be broadcast from the studio and relayed to London and other stations on Sunday, February 6. The service will be preceded by a broadcast of the bells from St. Luke's Church, Bold Street, rung by St. Nicholas's bellringers.

An hour's programme devoted to the lesser-known works of Coleridge-Taylor will be given on Wednesday, February 9. The compositions include the St. Agnes Eve Suite and the incidental music written for the play *Nero*. Mr. Sumner Austin (baritone) will sing several of Coleridge-Taylor's songs.

## HULL.

THE local concert on Thursday, January 27, will include a one-act play entitled *13 Simon Street*, songs by Miss Miriam Benham, and a twenty-five minutes' violin recital by Miss Una Cheverton, who will give works by modern composers. The second of the series of talks to schools on *How Our History Grew* will be broadcast on Friday, January 28. The talks on the French Revolution which are being given by Dr. Jordan will be continued on Thursday, January 27.

## BIRMINGHAM.

AN Orchestral Concert, relayed from the Institute, West Bromwich, on Tuesday, January 25, which Mr. Joseph Lewis is conducting, contains several items which are always accorded an enthusiastic reception. Tchaikovsky's orchestral suites are among his most popular works, and from them will be included the Theme and Variations from his suite upon themes from Mozart, and his famous *Solennelle Overture*. The soloists are Frank Webster (tenor) and Nigel Dallaway, who will play the first movement of the *Pianoforte Concerto in A Minor*, by Grieg. The concert concludes with the tone poem, *Finlandia*, by Sibelius.

The City of Birmingham Police Band will give a performance from the studio on Wednesday, January 26, by permission of the Chief Constable. The Band will be conducted by Mr. Richard Wassell, Organist and Master of the Choristers of the Parish Church of St. Martin's, Birmingham, who is their musical director.

An interlude of 'Harmony, Syncopation and Comedy' will be given by Jeane Paule and Leonie Lascelles on Thursday, January 27. A similar concert will also be heard on Saturday, January 29, when the artists will be Harold Kimberley, Alma Vane and Patricia Rossborough.

Miss Marie Dainton will be heard in a number of original songs, monologues, and impersonations of well-known stage favourites during the programme on Tuesday, January 25.

An event of particular interest to local listeners is the opening recital on the new organ of Lozells Picture House, which will be broadcast on February 7. This organ has been specially adapted for broadcasting.

## PLYMOUTH.

THE Band of the Royal Marines (Plymouth Division) under the direction of Lieut. F. R. G. O'Donnell, M.V.O., will again broadcast from the Plymouth Studio on Wednesday, January 26; their programme, which begins at 9.15, will include items by Wagner, Mozart and Gounod, in addition to pieces by modern composers. There will also be cornet solos by Sergeant J. Tulley and solo bassoon items by Musician W. Piper. Mr. Cyril Clensy (entertainer), well known for his imitations of famous artists, will also be heard in a twenty minutes' interlude—his first appearance at the Plymouth Studio. Early the same evening, the Cymric Vocal Trio will give an half hour's programme of solos, duets and trios.

A short pianoforte recital by Mr. Morris Gilbert, the well-known West Country composer, will be given at 6 p.m. on Saturday, January 29.

Miss Gladys Watmouth (soprano), will make her first appearance at the Plymouth Studio at 6 p.m. on Monday, January 24, in a ballad recital.

An interesting feature in next week's talks from Plymouth will include a transmission to schools entitled 'Sea Shanties,' which Mr. Douglas M. Durston is giving on Friday, January 28. Mr. Durston will be assisted by members of the Hoe Grammar School Boys' Choir, with illustrations of this particular type of chorus songs. Forthcoming talks are: Dr. H. Fisher, 'The Training of Ear Perspective' (Illustrated at the piano); Mr. F. S. Russell: Another of his series on Marine Life; Mr. C. W. Braeken: 'Insect Visitors from Abroad.'



**The Children's Corner.****The London and Daventry Radio Circle.****Fine Start Towards Second 10,000 Members.**

THE New Year brought a sudden and very pleasing addition to the number of members of The London and Daventry Radio Circle, no fewer than 250 members being enrolled in the first four days. At the moment of going to press the total membership on the books is 10,923.

Listeners will remember our successful efforts to increase the membership of the Circle to 10,000 before Christmas. How about a membership of 20,000 by next Christmas? It would be a fine thing to accomplish, and there is little doubt that with the co-operation of existing members we could manage it. Progress, as it is made, will be recorded from time to time in *The Radio Times*.

**'Request Week.'**

So far as we can judge from the opinions which have reached us from listeners—and the number of such opinions was very large—the recent 'Request Week' Programmes were very popular, as was the idea underlying the scheme. It is an experiment which we hope to repeat in the course of the next few months and, perhaps, again at intervals of, say, every six months.

The next 'Request Week' could be made still more popular and representative if listeners would begin forthwith to keep a list of the Children's Hour items which they like best—together with the name of the performer in each case—marking them in some way which indicates degree of popularity. This would make it easy, when the date of the next 'Request Week' is announced, to pick out the half-a-dozen items which it is most desired to hear again.

**This Week's Programmes.**

On Monday, January 17, Miss Cecil Dixon (freshly returned from winter sports in Switzerland) will play piano solos once more, and Mr. R. F. Palmer will sing. Miss Christine Silver—visiting the Children's Hour for the first time—will tell the well-known Hans Andersen tale of 'The Swineherd.'

On Tuesday, January 18, Miss Mavis Bennett will sing. As a further musical item, Mr. V. Hely-Hutchinson will give the third instalment of his series, 'Brothers of the Band.' This time, he will deal with the viola and the double-bass. Mr. E. Le Breton Martin will tell another of his new group of adventure stories, the title of this one being 'The Treasure of San Rosario.'

On Wednesday, January 19, we are to have piano solos by Mr. Gordon Bryan—a well-known and popular artist in Children's Hour programmes. Another welcome visitor will be Mr. Harcourt Williams, who will tell the story of 'Valentine Orson.' The other story on this day will be 'Billy,' by Mr. H. Mortimer Batten. We need only say that this particular story is on the level of the rest of the 'Batten stories' for our listeners to know that it is well worth their attention.

On Thursday, January 20, there will be more songs with choruses—the solo part being taken by Mr. J. R. Castling, and the rest by anybody who happens to be present. These 'chorus days' have become popular, and we hope that this one will be no exception. The story of the day will be 'Lady Alisoun and the Golden Bird,' a thrilling tale by Mr. Geoffrey Vickers. Mr. L. G. Mainland

will round off the programme by a talk on 'The Zoo School.'

On Friday, January 21, there will be an interesting item—the first of its kind, so far as the Children's Hour is concerned—in the shape of harp solos by Miss Sidonie Goossens. There will also be songs by Mr. A. S. Hibberd. The story on this occasion will be the 'Winnie-the-Pooh' adventure, entitled 'The Expedition to the North Pole.'

On Saturday, January 22, the Daventry Quartet will play selections. There will also be another 'Children's News' bulletin. The story will be Mrs. Mabel Marlowe's 'The Order of the Bath'—



Community Singing at the Zoo.

which, in our opinion, is one of the best she has written.

**Talks Worth Hearing at Manchester.**

Two new series of talks will be given in the week beginning Monday, January 24, for listeners to the Manchester Children's Hour. The first is on Wednesday, when Miss Violet Fraser will read Chapter One of the 'Fairyland of Nature,' an attempt to picture month by month the wonderful happenings in the world of flowers and beasts. The other series is entitled 'Pets and their Care,' and the first talk on Thursday is about the dog. These talks will also be given monthly, and it is hoped that children will co-operate and send in any suggestions or hints as to the comfort and happiness of their pets. The chief musical feature of the week is on Friday, when the story of the opera, *Lohengrin* will be read. This will be illustrated by the Sunline Trio and Mr. Harry Hopewell, who will sing the King's Aria.

**THE REV. H. R. L. SHEPPARD, C.H.**

Not the least welcome and popular among the New Year Honours was the distinction of Companion of Honour which was conferred on the Rev. H. R. L. Sheppard. The membership of this Order is strictly limited, and though the Companionship carries with it no official title, it stands out as a special mark of recognition for work nobly done. Listeners everywhere will offer Mr. Sheppard their heartiest congratulations on the honour that has been conferred upon him, coupled with the hope that he will before long be completely restored to health and be able to continue his services to the Church and the world.

**Broadcasting and the Music-Halls.****The Position in Germany.**

THE difficult question of the growing competition between broadcasting and the entertainment industry is not confined to any one country. It is still the subject of keen controversy in England and in America, and now in Germany it has become so acute that a special meeting of the International Music-Hall Managers' Association was recently convened in Dusseldorf, at which the subject was considered in all its bearings. At this meeting a survey of the whole question was made by Mr. Sachs, of Berlin, and his observations made very interesting reading for us in this country.

After eulogizing broadcasting as 'the unparalleled miracle of our civilization' and 'a divine gift,' he described it as 'the rival of the stage, the concert, the music-hall, the cinema, the cabaret and the dance hall, because it tends to replace all these institutions at a very moderate cost to the listener.' For any of these branches of the entertainment industry to attempt to fight broadcasting is impossible in the view of Mr. Sachs. 'We can only consider,' he said, 'how to prevent it from becoming too powerful an adversary. Perhaps we should even try to get it to help us, instead of opposing us.'

Mr. Sachs found consolation, however, in the thought that people will always crave for contact with the actual personality of the artist, without any intermediary coming between; and in this way he believed broadcasting could actually help the music-halls, for listeners would want to see, face to face, the artist whom they had heard by radio—always provided that the artist has sufficient personality to

inspire their interest. In another way, too, broadcasting could help the rest of the entertainment world—by vastly increasing its public. He believed that many people who had never previously taken any interest in the stage or music-hall could be won over by broadcasting.

For this reason, Mr. Sachs entirely disagreed with the policy of binding music-hall artists, by contract, not to broadcast. This, he thought, would be not only anti-social, but also unreasonable, for the broadcasting of music-hall artists would contribute to their popularity, and increase the number of music-hall patrons.

These opinions, of course, apply primarily to conditions as they are in Germany to-day. But all who are interested in the developments in broadcasting that are being made so rapidly in Great Britain, will hear of Mr. Sachs's suggestions with special interest. The problems which the Germans are facing are common to all countries where broadcasting has entered into the daily life of the people. By learning what other nations are doing to solve these problems, we, in Britain, may be helped to overcome the difficulties with which we are faced.

**PROGRAMME INDEX.**

SUNDAY .....	105, 106, 107
MONDAY .....	108, 109, 110, 111
TUESDAY .....	112, 113, 114
WEDNESDAY .....	115, 116, 117, 118, 119
THURSDAY .....	120, 121, 122, 128
FRIDAY .....	123, 124, 125
SATURDAY .....	126, 127, 128

## A Breath of Fresh Air.



In this column A. Bonnet Laird answers some of the many letters he has received lately from nature lovers.

### The Domesticated Robin.

THOSE who have robins in their gardens—and where is there a garden without one?—need no persuasion from me to watch these fascinating, impudent, jealous jewels of birds all through winter till spring comes round again. Those who do so will see many an odd little comedy or tragedy of bird life, such as is recorded by J. G. H., of Bath. He tells of a last winter's robin—companion of all the dark days—who, in the spring, was seen paying a newly-arrived female the prettiest compliment he knew—feeding her with worms.

The watchers in the garden saw them collect each fragment of grass, stick, and leaf that went to make their nest; noted gleefully one morning the four speckled eggs, and viewed, just too late to prevent it, the tragedy that overtook the family just after the eggs were hatched—the sudden spring of a cat which robbed them of the mother bird.

To their delight, the father, from that day, took entire charge of the family; flying indoors to perch on clock or gas-bracket, at each meal-time, until scraps—bread-and-butter, and so on—were thrown on a paper spread on a side table. These he would break up into tiny fragments and carry away to the nest, making a score of journeys, or more, at each feeding-time.

All his spruceness left him. Family cares weighed on him so that he had no time for his own toilet; but as they watched him grow more ragged they saw him, too, dutifully, patiently, teach the young birds to fly, until, not so long ago, when he had passed them out as skilled pilots, he sent each of them into the world with a fierce fatherly peck of 'Good-bye—and don't let me see you back!'

He is his own old well-groomed self again now, and once more monarch of the garden. No wonder, then, that his hosts are watching so eagerly for his next romance.

### Flood Time.

We, at home, can hardly gauge the terror and devastation which fire or flood spreads among the folk of the wild. A listener on the banks of the Tweed gives us a momentary glimpse. His letter pictures a recent flood, when sheaves of corn and logs were snatched away by the rush of water. On one sheaf sat a rat, contentedly nibbling at the ears of corn; on one of the logs, by way of contrast, a rabbit, terrified, as if it knew its fate, the moment the swollen waters reached the sea.

### Wembley's Weasel.

How close to London can the wild life of the countryside be found? I have a letter from Wembley telling of a weasel at bay in a clump of Michaelmas daisies, defying with sudden turn and menacing jump a couple of cats, till their owner chased them away and allowed it to retire. How near town, I wonder, has a weasel in its wild state been seen of recent times?

[A. Bonnet Laird dispatches one of his broadcast books this week to the sender of the most interesting item of Nature news—Mr. E. Whitfield, Bearnsmoor, Llanfairsfechan, Carnarvonshire.]

## Listeners' Letters.

### Mr. T. P. O'Connor's Appeal.

MAY I ask you to announce that the result of my broadcast appeal on Sunday, December 5, on behalf of the Queen's Hospital for Children, Bethnal Green, has amounted, up to the time of my writing, to the sum of £1,000? This leaves still a balance of £5,000 to be obtained to make it possible for the full work of the hospital to be carried on this year. I am hopeful that the public will respond to this crying need for a most beneficent institution.—T. P. O'CONNOR, London, S.W.1.

### Seeing with the Mind's Eye.

A RECENT article in *The Radio Times* dealt with the subject of wireless plays as a stimulus to the imagination, but, on discussing the question with a number of fellow-listeners, I have come to the conclusion that a really keen sense of 'mental vision' is comparatively rare. Anything which tends to foster this quality is devoutly to be wished—for to be without imagination is as bad as, if not worse than, being without a sense of humour.

About a year ago, the B.B.C. gave us the Balcony Scene from *Romeo and Juliet*, late one night. I had taken the 'phones up to bed, and I listened with open eyes in the dark—and then I saw the perfect Romeo and the perfect Juliet, in a setting such as I have never seen on any stage—the magic of the verse and the beauty of its delivery were a revelation, and though I know every word of the scene by heart, I felt I was really hearing it for the first time. I have had similar experiences since then, and I feel convinced that the gift of mental vision can be greatly stimulated by means of wireless plays and operas.

I have not actually seen *The Yellow Jacket* on the stage, but in the recent B.B.C. performance of this play I was quite absorbed, as much in the strangely beautiful 'scenery' in which the characters appeared to me to move and have their being as in the humour and charm of the words they spoke. But a fellow-listener could 'make nothing of it,' because she could not 'see' it. Let all listeners learn to make something good to see out of the things they hear.—MURIEL PASSINGHAM, Olive Road, Cricklewood, N.W.

### The Speaking of English.

WHY can we not use our language as the Italians use theirs? Simply, straightforwardly, classically, from peasant to Pope. In England every additional £1,000 per year of income is brought out in affectation of language, whilst the workman glories in his vulgar dialect. There is no language so beautiful as English, but surely no language is so vilely murdered as English is in so-called elocution.—(Mrs.) LILLIAN DIXON, Sacriston, Durham.

### The Case for an All-Welsh Station.

THE question of an 'All-Welsh Station' is being freely discussed throughout the Principality. It is a question which arrests the thoughts of all who profess any love for Wales and all that word stands for, and who realize the immense influence that wireless has grown to be in the world. I have been destined to spend my days in a remote village, lost amidst the majestic ranges of Welsh mountains, too small a speck to be placed on a map, but, on the other hand, too much alive in its thirst for knowledge to be unmoved by the wonders of science. To no one has wireless made more of a difference than to the inhabitant of such a village. The rustic has been taken into a new world and now, as soon as his daily task is over, his shop is closed, or his animals fed, he can sit before his fire and listen to and enjoy the world's greatest talent in all spheres. It means nothing less than the opening up of a new world. The Welsh countryman could appreciate these efforts more if he could be given a programme in his own vernacular. Indeed, you people in London would be surprised how the country folk hereabouts flock into the houses of those who possess wireless sets when there is a 'Welsh Night' on.

Perhaps you would be surprised, Mr. Editor, if you knew how great a number of the people of Wales, though they can speak English, are not sufficiently conversant with that language to follow the English programmes with full appreciation. Moreover, there are the old folk who would enjoy the religious services and hymns in their native tongue.

On the other hand, there are those who can appreciate the present English programmes, but who feel that we in Wales have our own talent, and that there are movements in the Wales of to-day—for example, in Drama—which would certainly benefit should they enlist the support of wireless.—C. EVANS, Tregavon, Cardiganshire.

### The Dublin Programmes.

Is there any good reason why *The Radio Times* does not include the Dublin evening programmes?—A 'FURNESS' LISTENER, Ulverston.

[The Dublin Station is not under the control of the B.B.C., and its programmes are printed, with those of other Dominion and foreign Stations, in our contemporary, *World Radio*.—Editor, *The Radio Times*.]

### Julius Caesar and the Tower of London.

In his interesting talk about the Tower of London in connection with the recent broadcast, on December 9, of the Ceremony of the Keys, Mr. Trevor Clark seemed to accept the tradition that Julius Caesar had something to do with building the Tower of London. Julius Caesar's longest expedition to England lasted about two months—July to September, 54 B.C. He crossed the Thames, possibly near Burntford, where it was just possible to cross on foot, and no other mention is made of the Thames as far as concerns his military movements. He seems to have kept to the interior of Kent, and would certainly have had no time to establish a permanent camp at London. He would have mentioned it, had he done so. It is very probable that (Claudius) Caesar established a 'camp' about A.D. 43.—A. H. DAVIES (Editor of 'Caesar and the Germans'), Broadstairs, Kent.

### Identifying British Stations.

As a listener who experiences difficulty in identifying stations, it occurs to me that the present system of announcing could be improved. To a foreigner, identification of our English Stations must be hard when one hears, for instance, 'this is Glasgow calling.' Why 'this is'—and 'Station calling'? In my opinion, it would be far better to say 'Glasgow! Glasgow!' Nothing else—just the Station's name repeated twice, slowly and clearly. Listening one Sunday evening, I received through my loud speaker the word 'Stuttgart' and later, 'Oslo'—nothing but these words with appreciable pauses afterwards, and in a second I was sure which Station I was listening to.

If this could be declared the custom through the Geneva organization, I feel sure that Europe as a whole would be benefited. We English people may sacrifice just a little and in return gain a benefit from our foreign neighbours.—L. G., Cowes, Isle of Wight.

### Flecker's Life.

I SEE that your brief notice of my son, James Elroy Flecker, in a recent issue of *The Radio Times*, was taken from his 'Life and Letters.' No doubt many of your readers would like to know that this book is published by Blackwell, of Oxford, at 7s. 6d.—S. FLECKER, Belmont, Radcliffe Road, Croydon.

### NOTICE TO READERS.

The Editorial address of 'The Radio Times' and of the British Broadcasting Corporation, is Savoy Hill, Strand, London, W.C.2.

RATES OF SUBSCRIPTION to 'The Radio Times' (including postage): Twelve Months (Foreign), 15s. 3d., Twelve Months (British), 13s. 6d.

# THE "DIRECT WAY" OF LEARNING LANGUAGES.

## How to Learn French, German, Spanish or Italian in a Few Months by the New Pelman Method.

**D**O you think that you could pick up a book written in a Foreign Language—a language of which you do not know a syllable—and not containing a single English word, and read it through correctly, without once referring to a dictionary?

Most people will be inclined to say that such a feat would be impossible.

Yet this is just what the new "direct way" of learning languages, as taught by the well-known Pelman Institute, now enables you to do.

The new method is a remarkable educational achievement. It is bound to modify profoundly the normal methods of learning languages. It has already been applied with great success to German, French, Spanish and Italian, and, being a scholarly method as well as an interesting one, it is winning not only widespread popular support, but the high approval of educational authorities.

### Remarkable Letters.

Hundreds of letters have been received by the Languages Department of the Pelman Institute from men and women who have learned French, German, Spanish or Italian by this direct method. Here are a few examples, which speak for themselves:—

*"I have learnt more French during the last three months from your Course than I learnt during some four or five years' teaching on old-fashioned lines at a school." (S. 382.)*

*"I feel you will be interested to know that I have obtained a remunerative post in the City, solely on the merits of my Italian. As you know, I WAS ABSOLUTELY IGNORANT OF THE LANGUAGE BEFORE I BEGAN YOUR COURSE EIGHT MONTHS AGO. My employer is not only satisfied with the way in which I am able to conduct his Italian correspondence, but he has also congratulated me on my Pronunciation. He is an Italian himself." (I.F. 121.)*

*"As I have now finished the French Course, I should like to tell you how much I have appreciated it. The work has been a pleasure all along, and I have felt that my knowledge and facility in the language were increasing without laborious effort on my part. I am engaged now in reading Huysman's 'La Cathédral,' and I very much enjoy my French reading." (C. 961.)*

*"I have just returned from a visit to Spain, never having previously heard Spanish spoken. It says much for the perfection of your 'Guide to Pronunciation' that I have not had to alter my ideas on pronunciation in any particular, finding everything spoken just as I had imagined. My accent was also praised, in one case by a lawyer, who should be qualified to judge, and who impressed on me that he was not flattering me." (S.W. 372.)*

*"I cannot speak too highly of your system. I calculate that I have spent some 100 hours on German studying by your methods; the*

*results obtained in so short a time are amazing. With the aid of a dictionary, on account of the TECHNICAL vocabulary, I now find I can master German scientific reports published in their own tongue. I cannot tell you what a help this will be in my work. The whole system is excellent." (G.P. 136.)*

### A Personal Experience.

The present writer can speak with enthusiasm and conviction regarding this new method. Calling one day at the Institute he was asked whether he knew any Spanish. His reply was that, with the exception of a few words like "primavera," he was entirely unacquainted with the language. He was then handed a little book of 48 pages, printed entirely in Spanish, and asked to read it through. There was not an English word in the book, yet, to his great amazement, he was able to read it through from cover to cover without a mistake. He was particularly astonished at this, in view of the fact that he had no ability as a linguist. He was convinced then that the Pelman method was the best method of learning a Foreign Language that had ever been devised, and he only wished that he had been taught in this way when he was at school.

### No Translation.

The great merit of this new method is that it enables you to learn French in French, Spanish in Spanish, Italian in Italian, and German in German. There is no question of translating these languages into English or vice versa: You learn the language as a native of Spain, Germany, Italy or France learns it. In other words, you learn to think directly in the particular language in question. This makes for increased fluency, as, when speaking the tongue, you do not have to stop and think of the foreign equivalent of an English phrase, as so frequently happens when a language is learnt by the old-fashioned methods.

A second point is that there are no vocabularies to be learnt, parrot-fashion, by heart. You pick up the words you need by using them, and in so natural a way that they stay in your mind without effort.

### Grammatical Difficulties Eliminated.

A third merit—and an important one—is that when you start learning a language by this method you do not find your way barred by a barbed-wire entanglement of grammatical complexities. You learn the language straight away, and the grammatical difficulties do not exist. This makes the system most interesting, so that you continue the study until you have acquired the language.

Here is a letter which emphasises the interesting nature of this method:—

*"I should like to express my appreciation of the excellent manner in which the Course is conducted. I find no difficulty at all in following out the lessons, and the progressive manner in which the lessons follow one another is really A1. . . . I am much astonished that such a method has never been thought of before, as it is undoubtedly the easiest and most interesting, and I feel convinced that if this method becomes more widely known it will be adopted as a standard. It is a positive pleasure, and I am enjoying my studies instead of plodding on as I used to do." (S. L. 148.)*

Fourthly, there are no classes to attend. The whole of the instruction is given by correspondence, so that you can learn French, German, Italian, or Spanish in your own time. The method is as simple as it is interesting, and as interesting as it is effective. General Sir Aylmer Haldane, G.C.M.G., K.C.B., D.S.O., writes: "I find that the Pelman method is the best way of learning French without a teacher." And others write to say the same of the other three languages.



The Pelman method of learning Foreign Languages is fully explained in four little books, one for each language. These books are entitled respectively "How to Learn French," "How to Learn Italian," "How to Learn German," and "How to Learn Spanish." In order to obtain a free copy of any one of these books, fill up the following coupon and post it to-day to the Pelman Institute (Languages Dept.), 95, Pelman House, Bloomsbury Street, London, W.C.1, and the book you want, with full particulars, will be sent to you by return of post. Call or write to-day.

### FREE APPLICATION FORM.

To THE PELMAN INSTITUTE (Languages Dept.),  
95, Pelman House, Bloomsbury Street, London, W.C.1.

Please send me, gratis and post free, a copy of

"HOW TO LEARN FRENCH" | "HOW TO LEARN SPANISH"  
"HOW TO LEARN GERMAN" | "HOW TO LEARN ITALIAN"  
(cross out three of these)

and full particulars of the New Pelman Method of Learning Foreign Languages without using English.

NAME.....

ADDRESS.....



# PROGRAMMES FOR SUNDAY (January 16)

The Reproduction of these Copyright Programmes is strictly reserved.

2LO LONDON. 361.4 M.

### 3.30 MILITARY BAND PROGRAMME

THE WIRELESS MILITARY BAND, conducted by  
 Lieut. B. WALTON O'DONNELL  
 SOLLOWAY (Violin)  
 FRANK TITTERTON (Tenor)  
 THE BAND  
 Overture to 'The Flying Dutchman'... Wagner  
 FRANK TITTERTON  
 Alas, that Spring should Vanish with the Rose  
*Liza Lehmann*  
 A Feast of Lanterns ..... *Bantock*  
 Mary of Allendale ..... *Lane Wilson*  
 THE BAND  
 Three Humoresques, Op. 28 *B. Walton O'Donnell*  
 Pride and Prejudice  
 Prevarication  
 Petulance and Persuasion  
 SOLLOWAY  
 Larghetto ..... *Handel*  
 The Wind ..... *Vescey*  
 THE BAND  
 Suite, 'Wand of Youth' ..... *Elgar*  
 March; The Little Bells; Moths and Butterflies; The Tame Bear; Wild Bears  
 FRANK TITTERTON  
 Brown is My Love, but Graceful ..... *Quilter*  
 Life and Death ..... *Coleridge-Taylor*  
 THE BAND  
 Capriccio Espagnol ..... *Rimsky-Korsakov*  
 Alborada—Variations—Alborada  
 Scena e Canto Gitano—Fandango Asturiano  
 SOLLOWAY  
 Romanza Andaluza ..... } *Sarasate*  
 Jotanavarre ..... }  
 THE BAND  
 Ballet Music, 'Coppelia' ..... *Delibes*

5.15 Prof. JAMES MOFFATT, D.D., D.Litt., Introductory Talk to 'Tales from the Old Testament.' S.B. from Glasgow

THIS Talk introduces a series of tales from the Old Testament that will be given on Sunday afternoons every week from next Sunday until after Easter. They will deal with well-known episodes in the lives of such great Biblical figures as Abraham, Jacob, and Joseph, winding up with the story of Gideon from the Book of Judges. The Rev. James Moffatt, who gives this introductory Talk, is Professor of Church History at the United Free Church College, Glasgow. He is well known as a translator and editor of the Old and New Testaments.

5.30 CHILDREN'S SERVICE  
 Conducted by the Rev. Canon C. S. WOODWARD

8.0 RELIGIOUS SERVICE  
 FROM THE STUDIO

MUSIC by the CHOIR OF ST. JOHN THE EVANGELIST, Wilton Road, Pimlico, S.W.  
 Hymn, 'As With Gladness' (omit 3). (Tune: 'Dix')  
 Lesson  
 Magnificat ..... *Byrde*  
 Address by the Rev. G. F. POLLARD  
 Hymn, 'Jesus Shall Reign' (Tune: 'Truro')  
 Hodie Christus natus est ..... *Sveelinck*  
 All This Night ..... *Weatherly*  
 Surge! Illuminare ..... *Cobb*  
 Whom Saw Ye, O Shepherds? ..... *Dering*

8.55 THE WEEK'S GOOD CAUSE: The John Benn Hostel and Milner Hall. Appeal by Mr. J. J. MALLON, J.P.

THE idea behind the establishment of this new Hostel, Club, and Community Centre in the heart of the East-end is to provide a decent home for boys who have left behind them, with school age, the majority of the sheltering influences that protect the child. At the age of fourteen the East-end boy goes out to become a wage-earner, and if his home conditions are bad, if he has no proper home, he has at present no alternative but the common lodging-house. The John Benn Hostel is designed to meet this need by providing a home where boys between the ages of fourteen and eighteen can live, and find facilities for recreation—there is already a swimming-bath on the premises, and a gymnasium is to be established—handicrafts, and social intercourse with the people of the neigh-



Bussell

Professor JAMES MOFFATT,

whose introduction to his forthcoming series of 'Tales from the Old Testament' will be given at Glasgow to-day at 5.15 and will be S.B. from all stations.

bourhood. There could be no better indication of the importance of the scheme than the fact that it is being promoted by the authorities of Toynbee Hall—whose Warden, Mr. J. J. Mallon, who is noted for his social work in the East-end, is making the appeal to-night—and made possible largely through the generosity of Sir Ernest Benn, after whose father, that hero of Stepney, the hostel is to be named.

Donations should be sent to the Warden, Toynbee Hall, 28, Commercial Street, E.1.

9.0 WEATHER FORECAST, GENERAL NEWS BULLETIN; Local Announcements

9.15 GRIEG

ISABEL F'ANSON (Soprano)  
 LESLIE ENGLAND (Pianoforte)

THE WIRELESS-SYMPHONY ORCHESTRA  
 Conducted by PERCY PITT

ORCHESTRA  
 Overture, 'In Autumn'  
 First Spring (For Strings)  
 Norwegian Wedding Procession

IN the opening Overture, which developed from the theme of one of the Composer's songs, we have an impression of scenes and moods at

the fall of the year in Norway, Grieg's native country. The music is richly coloured, and its rhythms are often exhilarating.

There is an Introduction (*Slowish*), in which Strings and Woodwind call to each other, the Melody having a characteristically Griegian shape. This leads into a quick and agitated portion, Strings and Wind having a dozen bars of urgent minor music, that bring us to a still more furious pace and to the First Main Tune, with its insistent prancing rhythm.

A quiet bit leads to the Second Main Tune, which Clarinet and Horns share. This is a graceful, rising theme, with a cheery lilt at the end of it. A naive, folk-song-like Tune in the Strings, that soon follows, is a sort of subsidiary theme.

On this material, with many dainty little episodes, the work is built up.

ISABEL F'ANSON (with Orchestra)  
 A Swan  
 Solveig's Song from 'Peer Gynt'

PEER GYNT, in Ibsen's famous play, has wasted his whole life, wandering over the earth, having all kinds of fantastic experiences, but never doing anything very useful, bent only on the glorification of Self.

Once he has a vision. He sees Solveig, who loves him, sitting spinning outside the old hut he built long ago for himself and her. She is now a middle-aged woman, but still fair-haired and comely, and as she spins she thinks of Peer and sings 'Thou wilt return some day and find me waiting.' This is known as *Solveig's Song*.

LESLIE ENGLAND (with Orchestra)  
 Concerto for Pianoforte and Orchestra

THIS is perhaps the most popular of Grieg's larger works. It was written in 1868, when the composer was twenty-five years old. There are three Movements, Allegro Molto Moderato—Adagio—Allegro Moderato Molto e Marcato.

ISABEL F'ANSON (with Piano)  
 Two Brown Eyes (Hans Andersen); A Water-Lily (Ibsen)

IN the *Two Brown Eyes* of which he joyously sings the lover has discovered a light that tells him the maiden is his now and for ever.

In a *Water-Lily* the lover, bringing flowers to his maiden, reminds her that a water-sprite sleeps beneath the placid waters on which float the lilies. So, he says, as he wreathes the flowers around her, within her bosom sleeps a spirit.

LESLIE ENGLAND  
 Papillons  
 On the Mountains

ORCHESTRA  
 Lyric Suite

HENRY FINCK, the well-known American critic, once wrote Grieg to tell him that the famous Conductor, Seidl, had arranged four pieces for Orchestra from Grieg's *Lyric Suite* for Piano (known as 'Opus 54'), and had conducted them with great success.

Grieg was very much interested, as one might expect. After inspecting the orchestral score, he wrote to Finck, saying: 'Seidl's orchestration is undeniably very good from his point of view, but too heavy for my intentions.' Subsequently Grieg himself revised this orchestration, and published the result.

The whole of the original Suite for Piano is not included in the *Orchestral Suite*. The four pieces chosen are adequately described by their titles.

The FIRST is called *The Shepherd Boy*, the SECOND is a *Norwegian Peasant March*, the THIRD a *Nocturne*, and the FOURTH, *The March of the Dwarfs*.

# PROGRAMMES FOR SUNDAY (January 16)

## 5XX DAVENTRY. 1,600 M.

- 10.30 a.m. Time Signal, Weather Forecast
- 3.30-6.0 S.B. from London
- 8.0 S.B. from London
- 9.10 Shipping Forecast
- 9.15-10.45 S.B. from London

## 5IT BIRMINGHAM. 491.8 M.

- 3.30 S.B. from London
- 5.15 S.B. from Glasgow
- 5.30-6.0 S.B. from London
- 8.15 RELIGIOUS SERVICE FROM THE STUDIO.  
Introit, 'Cast Thy Burden' . . . . . Mendelssohn  
Hymn, 'Bethlehem, of Noblest Cities' (English Hymnal, No. 49)  
Reading  
Anthem, 'O Love the Lord' . . . . . Sullivan  
Religious Address by the Rev. W. W. COTTON (of Wyld Green Congregational Church)  
Hymn, 'The Race That Long in Darkness Pined' (English Hymnal, No. 43)
- 8.55 S.B. from London (9.10 Local News)

### 9.15-10.30 ORCHESTRAL CONCERT

THE STATION ORCHESTRA, conducted by JOSEPH LEWIS  
Overture, 'Fingal's Cave' . . . . . Mendelssohn  
DAVID BRYNLEY (Tenor)  
Go, Lovely Rose . . . . . Roger Quilter  
The Cobbler's End . . . . . David Brynley  
The Lake Isle of Innisfree . . . . . Angus Morrison  
The Sweet Nightingale . . . . . arr. Cecil Sharp  
GORDON BRYAN (Pianoforte) and Orchestra  
Pianoforte Concerto in D Minor . . . . . Bach  
Allegro; Adagio; Allegro  
ORCHESTRA  
Scherzo, 'The Flight of the Bumble Bee' . . . . . Rimsky-Korsakov  
DAVID BRYNLEY  
The Downs . . . . . }  
Mary and the Kitten . . . . . } Gordon Bryan  
Ariel's Mockery . . . . . }  
Love at First Sight . . . . . }  
Acceptation . . . . . }  
ORCHESTRA  
Ballet Suite, 'Sylvia' . . . . . Delibes

### EPILOGUE

## 6BM BOURNEMOUTH. 326.1 M.

- 3.30 S.B. from London
- 5.15 S.B. from Glasgow
- 5.30-6.0 S.B. from London
- 6.30-7.30 RELIGIOUS SERVICE  
Relayed from Christchurch Priory, Christchurch  
Address by the Rev. W. H. GAY
- 8.55 THE WEEK'S GOOD CAUSE
- 9.0-10.45 S.B. from London (9.10 Local News)

## 5WA CARDIFF. 353 M.

- 3.30 S.B. from London
- 5.15 S.B. from Glasgow
- 5.30-6.0 S.B. from London



Mr. Leslie England and Miss Isabel Anson, who are taking part in the programme of Grieg's music to be broadcast from London this evening (9.15).

### 8.15 RELIGIOUS SERVICE FROM THE STUDIO

THE CHOIR of Holy Trinity Church, Newport  
Hymn, 'As With Gladness Men of Old' (A. and M., No. 79)  
A Short Reading from the Scriptures  
Hymn, 'There is a Land of Pure Delight' (A. and M., No. 536)  
Anthem, 'Evening and Morning' . . . . . Oakley  
Religious Address by the Rev. HENRY MORGAN  
Hymn, 'The Day Thou Gavest, Lord, is Ended' (A. and M., No. 477)

8.55 THE WEEK'S GOOD CAUSE: The Prince of Wales' Hospital, Cardiff

9.0 WEATHER FORECAST, NEWS; Local News

### 9.15 AN HISTORIC CHOIR

THE STATION ORCHESTRA, conducted by WARWICK BRAITHWAITE  
London Symphony (1st Movement) . . . . . Haydn  
THE LAY VICARS OF WESTMINSTER ABBEY  
Anthems:  
I Will Lift Up Mine Eyes . . . . . Walker  
O For a Closer Walk with God . . . . . Stanford  
Jesu, the Very Thought is Sweet . . . . . Vittoria  
ORCHESTRA  
London Symphony (4th Movement) . . . . . Haydn  
LAY VICARS  
Negro Spirituals . . . . . arr. Burleigh  
I Got a Robe; Swing Low; De Gospel Train.  
ORCHESTRA  
The Leaves Be Greene . . . . . Byrd, ed. Terry  
Purcell's Suite from 'Dramatic Music' . . . . . arr. Coates  
LAY VICARS  
Glee, 'Queen of the Valley' . . . . . Callcott  
Part-Song, 'Linden Lea' . . . . . Vaughan Williams  
Glee, 'The Mighty Conqueror' . . . . . Webbe  
ORCHESTRA  
First Suite from 'The Gordian Knot Untied' . . . . . Purcell, arr. Holst

THE play *The Gordian Knot Untied*, for which Purcell wrote incidental music, seems to have disappeared, leaving no traces. A Gentle-



### A GLIMPSE OF CHRISTCHURCH PRIORY.

A religious service will be relayed to Bournemouth listeners from the Priory this evening at 6.30.

man's Journal in 1691-92 speaks of the author as a 'Gentleman who writ lately a most ingenious Dialogue concerning Women.'

Purcell's music consists of eight numbers, scored for Strings only. Mr. Holst has arranged these in two Suites and has added Wind parts, duplicating the Strings.

There are five pieces in this First Suite: (1) an Overture, in the characteristic form of the day (a slow Introduction, then a quick section in 'fugal' style, and a few slow bars to conclude); (2) a short Air, keeping up one rhythmic pattern; (3) a Rondeau Minuet, in which the leading tune comes round a number of times, with fresh themes between its appearances; (4) another Air, livelier and longer than the first; and (5) a Fig.

### LAY VICARS

Part-Songs ('The Little Sandman' . . . . . Brahms  
'O Peaceful Night' . . . . . German  
Carol, 'When the Crimson Sun')

### ORCHESTRA

Andantino in D Flat . . . . . Lemarc, arr. Holst

### 10.25-10.45 THE SILENT FELLOWSHIP

## 2ZY MANCHESTER. 384.6 M.

### 3.30 SYMPHONY CONCERT

HELEN ANDERTON (Contralto)  
DON HYDEN (Solo Violin)  
THE AUGMENTED STATION ORCHESTRA, conducted by T. H. MORRISON  
ORCHESTRA  
Overture, 'Benvenuto Cellini' . . . . . Berlioz  
HELEN ANDERTON  
Fair Spring is Returning . . . . . Saint-Saens  
DON HYDEN and ORCHESTRA  
Concerto for Violin and Orchestra in A Minor, Op. 82 . . . . . Glazounov  
Moderato; Andante; Piu Animato; Tranquillo, leading into Animando; Allegro  
HELEN ANDERTON  
Shine Agra . . . . . arr. Somervell  
The Fairy Lough . . . . . Stanford  
My True Love Hath My Heart . . . . . Ronald Tovey  
ORCHESTRA  
Fifth Symphony in E Minor, Op. 64 Tchaikovsky  
Andante leading into Allegro Con Anima; Andante Cantabile, Con Alcune Licenza; Valse, Allegro Moderato; Finale, Andante Maestoso; Allegro Vivace; Moderato Assai and Molto Maestoso; Presto; Molto Meno Mosso

5.15 S.B. from Glasgow

5.30-6.0 S.B. from London

### 8.0 RELIGIOUS SERVICE FROM THE STUDIO

Sacred Music by THE STATION QUARTET  
8.15 Hymn, 'Ye Watchers and Ye Holy Ones' (English Hymnal, No. 519)  
Bible Reading: I. John, Chap. IV, Verses 7-21  
Hymn, 'O Brother Man, Fold To Thy Heart Thy Brother' (Songs of Praise) (Tune: 'Intercession') (A. and M., No. 363)  
Address by the Rev. K. L. PARRY  
Hymn, 'Round Me Falls the Night' (English Hymnal, No. 272)  
Benediction

8.45 Sacred Music by THE STATION QUARTET

8.55 THE WEEK'S GOOD CAUSE: An appeal on behalf of the Bolton Infirmary by Mr. PERCY MUSGRAVE

9.0-10.45 S.B. from London (9.10 Local News)

# PROGRAMMES FOR SUNDAY (January 16)

## 6KH HULL. 288.5 M.

3.30 *S.B. from London*  
 5.15 *S.B. from Glasgow*  
 5.30-6.0 *S.B. from London*  
 8.15 RELIGIOUS SERVICE  
 FROM THE STUDIO  
 Conducted by the Rev. HERMON F. JOHNSON, Minister of Lambert Street Primitive Methodist Church. Assisted by the CHOIR, directed by H. WILSON  
 Hymn, 'We Love the Place O God' (P.M. Hymnal, No. 790)  
 Prayer  
 Lesson  
 Anthem, 'Come Unto Him' ..... (sung)  
 Address by the Rev. HERMON F. JOHNSON  
 Hymn, 'The Day Thou Gavest, Lord, is Ended' (P.M. Hymnal Supplement, 264)  
 Benediction  
 Vesper  
 8.55-10.45 *S.B. from London* (9.10 Local News)

## 2LS LEEDS-BRADFORD. 277.8 M. & 254.2 M.

3.30 *S.B. from London*  
 5.15 *S.B. from Glasgow*  
 5.30-6.0 *S.B. from London*  
 8.0-10.45 *S.B. from London* (9.10 Local News)

## 6LV LIVERPOOL. 297 M.

3.30 *S.B. from London*  
 5.15 *S.B. from Glasgow*  
 5.30-6.0 *S.B. from London*  
 8.0 ORGAN RECITAL by Mr. E. SANDERS, from St. James' Church, Toxteth Park  
 8.15 RELIGIOUS SERVICE  
 from St. James' Church, Toxteth Park. Address by the Rev. Canon J. C. How, Rector of Liverpool  
 8.55-10.45 *S.B. from London* (9.10 Local News)

## 5NG NOTTINGHAM. 275.2 M.

3.30 *S.B. from London*  
 5.15 *S.B. from Glasgow*  
 5.30-6.0 *S.B. from London*

## 8.10 RELIGIOUS SERVICE FROM THE STUDIO

Hymn, 'Jesu, Thou Joy of Loving Hearts' (M.H.B., No. 111)  
 Bible Reading  
 Hymn, 'To the Hills I Lift Mine Eyes' (M.H.B., No. 399)  
 Prayer  
 Anthem, 'O Gladsome Light' ..... Sullivan  
 Address by the Rev. C. H. HODGSON  
 Hymn, 'Now the Day is Over' (M.H.B., No. 884)  
 8.55-10.45 *S.B. from London* (9.10 Local News)

## 5PY PLYMOUTH. 400 M.

3.30 *S.B. from London*  
 5.15 *S.B. from Glasgow*  
 5.30-6.0 *S.B. from London*

## 8.0 RELIGIOUS SERVICE

Relayed from St. Andrew's Parish Church  
 General Confession and Prayers  
 Psalm No. 84  
 Lesson; Isaiah, Chapter 50, Verses 4-10  
 Nunc Dimittis  
 Prayers  
 Anthem, 'Light of the World' ..... Elgar  
 Hymn, 'As With Gladness Men of Old' (A. and M., No. 79)  
 Address by the Rev. GABRIEL HARRIS, Vicar of Walkhampton Church  
 Hymn, 'Lights Abode, Celestial Salem' (A. and M., No. 232)  
 Organ Voluntary, First Movement of Sonata in G Elgar  
 8.55 THE WEEK'S GOOD CAUSE: Appeal on behalf of the South Devon and East Cornwall Hospital  
 9.0-10.45 *S.B. from London* (9.10 Local News)

## 6FL SHEFFIELD. 272.7 M.

3.30 *S.B. from London*  
 5.15 *S.B. from Glasgow*  
 5.30-6.0 *S.B. from London*  
 8.15 RELIGIOUS SERVICE  
 Relayed from Nether Chapel  
 8.55-10.45 *S.B. from London* (9.10 Local News)

## 6ST STOKE. 288.5 M.

3.30 *S.B. from London*  
 4.15 *S.B. from Glasgow*

## 5.30-6.0 S.B. from London

8.15 RELIGIOUS SERVICE  
 Conducted by BISHOP WILLIS, D.D., Bishop of Uganda, from St. Peter's Church, Stoke-on-Trent  
 8.55-10.45 *S.B. from London* (9.10 Local News)

## 5SX SWANSEA. 288.5 M.

3.30 *S.B. from London*  
 5.15 *S.B. from Glasgow*  
 5.30-6.0 *S.B. from London*  
 6.30 RELIGIOUS SERVICE  
 Relayed from Walter Road Congregational Church. Address by the Rev. A. PENRY EVANS  
 8.0 *S.B. from London*  
 9.0 WEATHER FORECAST, NEWS; Local News  
 9.15-10.45 *S.B. from Cardiff*

## Northern Programmes.

### 5NO NEWCASTLE. 312.5 M.

3.30-6.0:—*S.B. from London*. 8.9:—*S.B. from London*. 8.55:—The Week's Good Cause: Appeal on behalf of the Tyneside Meat Traders' Charitable Association. 9.0-10.45:—*S.B. from London*.

### 5SC GLASGOW. 405.4 M.

3.30-5.15:—*S.B. from London*. Prof. James Moffatt, Introductory Talk to 'Tales from the Old Testament.' 5.30-5.8:—*S.B. from London*. 8.15:—Religious Service. *S.B. from Aberdeen*. 8.55:—*S.B. from London*. 9.15:—Symphony Concert. The Station Symphony Orchestra, conducted by Herbert A. Carruthers: A Fugal Overture (Holst); 9.25:—Eda Benne (Soprano) and Orchestra: Willow Song (Otello) (Verdi). 9.35:—Orchestra: Symphonic Poem, 'Tasso' (Liszt). 10.20:—Eda Benne: Morning Song (Mallinson); Sadness Light (Herbert Deavin); The Song of the Windmill (Alison Traversa). 10.30:—Orchestra: Miniature Fantasy; The Forgotten Rite (Ireland). 10.45:—Epilogue.

### 2BD ABERDEEN. 500 M.

3.30:—*S.B. from London*. 5.15:—*S.B. from Glasgow*. 5.30-6.0:—*S.B. from London*. 8.15-8.55:—Religious Service from the Studio, conducted by the Rev. D. C. Mitchell, North U.F. Church, assisted by the Choir of the Church. 9.0:—Weather Forecast, News. 9.10:—Concert, relayed from the Cowdray Hall. The Augmented Station Orchestra, conducted by Paul Askew: Overture, 'The Mastersingers' (Wagner). 9.20:—Marion Richardson (Mezzo-Soprano) and Orchestra: Laudamus Te (Mass in B Minor) (Bach); My Heart Ever Faithful (Bach). 9.30:—Orchestra: Ballet Egyptian (Ligeti). 9.40:—Marion Richardson: Peace (Schubert); Thine is My Heart (Schubert); Spring Waters (Rachmaninov). 9.50:—Orchestra: Four Indian Love Lyrics (Woodforde-Pindar). 10.0-10.30:—*S.B. from London*.

### 2BE BELFAST. 306.1 M.

3.30:—*S.B. from London*. 5.15:—*S.B. from Glasgow*. 5.30-6.0:—*S.B. from London*. 8.15-8.55 *S.B. from Aberdeen*. 9.0-10.45:—*S.B. from London*.



Mr. DON HYDEN, the violinist, will play the solo part in Glazounov's A Minor Concerto from Manchester [3.30].



THE LAY VICARS OF WESTMINSTER, whom Cardiff listeners will hear this evening in anthems and Negro Spirituals [9.15].



Miss HELEN ANDERTON, contralto, who is taking part in this afternoon's Symphony Concert from Manchester [3.30].

# PROGRAMMES FOR MONDAY (January 17)

**2LO LONDON. 361.4 M.**

**1.0-2.0 ORGAN RECITAL** by the Rev. CYRIL JACKSON, Succentor of Southwark Cathedral  
Assisted by HARRY BRINDLE (Bass)

Relayed from Southwark Cathedral

Alla Marcia ..... *Sinding*  
Elizabeth's Prayer (Tambäuser)

Wagner, arr. Henderson  
Solos (Though Faithless Men..... *Meyerbeer*  
(The Lord is My Light ..... *Allitsen*  
Psalm Prelude No. 2 ..... *Herbert Howells*  
La Petite Berger..... } *Debussy*  
La Fille aux Cheveux de Lin ..... }

Solos (Hymn to the Creation) ..... arr. *G. O'Connor Morris*  
(Alleluia ..... *Herbert Brewer*  
Triumphal Song ..... *Herbert Brewer*

**3.0 BROADCAST TO SCHOOLS: Mr. H. G. PONTING,**  
'The South Pole'

**4.0 TIME SIGNAL, GREENWICH. THE ROYAL**  
**AUTOMOBILE CLUB DANCE BAND** from the R.A.C.

**4.15 Prof. G. ELLIOT SMITH, 'The Movements of**  
**Living Creatures'**

**4.30 THE ROYAL AUTOMOBILE CLUB DANCE BAND**  
(Continued)

**5.0 Household Talk: Economics in Coal: Miss**  
**HELEN GREIG SOUTER**

**5.15 THE CHILDREN'S HOUR: PIANO Solos,**  
Songs and a Story by R. F. PALMER;  
'The Swineherd,' told by CHRISTINE SILVER

**6.0 ALEX FRYER'S ORCHESTRA** from the Rialto  
Theatre

**6.25 Wireless Association Quarterly Bulletin**

**6.30 WEATHER FORECAST, FIRST GENERAL NEWS**  
**BULLETIN**

**6.45 ALEX FRYER'S ORCHESTRA** from the Rialto  
Theatre

**7.0 Mr. DESMOND MACCARTHY, Literary Criticism**

**7.15 THE FOUNDATIONS OF MUSIC**

Bach's 48 Preludes and Fugues, played through  
consecutively at this hour daily throughout  
the month

**7.25 M. STÉPHAN: French Reading, Molière's**  
**'Le Bourgeois Gentilhomme,' Act II., Scenes**  
**2, 3, 4 and 5 (Pages 12-16)**

**7.45 VOICE AND PERSONALITY—1**

A Special Test conducted by  
Professor T. H. PEAR (Professor  
of Psychology, Manchester  
University)

*S.B. from Manchester*

(Full details of this interesting  
broadcast are given in  
Professor Pear's article on page  
101 of this issue.)

**8.0 A LECTURE RECITAL**

'THE FOLK MUSIC OF SPAIN'

Illustrated on the  
Spanish Guitar and Lute by  
JAN AND CORA GORDON

JAN and Cora Gordon have  
established themselves in  
the estimation of the reading  
public as the most charming of  
literary vagabonds. Their  
wanderings began in Spain,  
about which they have written  
(and illustrated) two delightful  
books—'Two Vagabonds in  
Spain' and 'A Donkey Trip  
Through Spain'

**8.30 Orchestra**  
Suite Pastorale ..... *John Ansell*



CORA and JAN GORDON,

who will illustrate with lute and guitar the  
lecture recital on Spanish folk music at 8 o'clock  
to-night from the London Studios.

**8.45 THROUGH ANOTHER'S EYES**

Played by ADOLPHE HALLIS

TURKEY (as seen by an Austrian and a Russian)  
Alle Turea (from Sonata in A) ..... *Mozart*  
Turkish March (from 'Ruins of Athens')  
..... *Beethoven, arr. Rubinstein*

FRANCE (as seen by a Russian)  
Children's Quarrel after playing in the Tuileries  
..... *Moussorgsky*

The Market Place, Limoges (from 'Pictures from  
an Exhibition') ..... *Moussorgsky*

**9.0 WEATHER FORECAST, SECOND GENERAL**  
**NEWS BULLETIN; Local Announcements**

**9.15 Special Feature**

**9.30 LIGHT MUSIC AND A FARCE**

*S.B. from Newcastle*

THE STATION OCTET

Overture to 'The Barber of Seville' ... *Rossini*

**9.40 'ADMIRAL PETERS'**

A Comedy in One Act, by W. W. JACOBS and  
HORACE MILLS

Presented by ERIC BARBER

Played by the STATION REPERTORY COMPANY

Cast:

George Burton (a Naval Pensioner) ..... *NORMAN FIRMIN*

Joe Stiles (an Old Messmate of Burton's) ..... *ERIC BARBER*

Mrs. Dutton ..... *SAL STURGEON*

**10.0 OCTET**

Basque Legend ..... *Maquarve*  
Three Dances (Nell Gwyn) ..... *E. German*

**10.15-11.0 MUSICAL PLAYS OF RECENT**  
**DAYS**

A Performance of Excerpts, conducted by  
JOHN ANSELL

EVA STERNROYD (Soprano)

THE WIRELESS ORCHESTRA

ORCHESTRA

Selection from 'Tell Me More' ..... *Gershwin*

EVA STERNROYD

Setting Sun (The Emerald Isle) (With Orchestra)  
..... *German*

There was Once a Pretty Peasant (Mirette)

..... *Message*

ORCHESTRA

Selection, 'The Cabaret Girl' ..... *Kern*

EVA STERNROYD

(With Orchestra)

In Love with Love (The Naughty Princess)

The First Embrace) ..... *Cuvelier*

ORCHESTRA

Selection from 'Sally' ..... *Kern*

**5XX DAVENTRY. 1,600 M.**

**10.30 a.m. Time Signal, Weather Forecast**

**11.0 THE DAVENTRY QUARTET** and CATHERINE  
AULSBROOKE (Contralto), ERNA SCHULZ (Violin),  
TOSTA DE-BENICI (Pianoforte)

**11.45 app. THOMAS THOMAS and MEGAN TELINI**  
(Duets)

**12.0 app. CONCERT (Continued)**

**1.0-2.0 S.B. from London**

**3.0 S.B. from London**

**9.10 Shipping Forecast**

**9.15 S.B. from London**

**9.30 MUSICAL PLAYS OF**  
**OLDER DAYS**

HAYDEN COFFIN

THE WIRELESS ORCHESTRA,  
conducted by JOHN ANSELL

Selection from 'Dorothy'

..... *Cellier*

HAYDEN COFFIN

Who Sings of England (Young  
England)

ORCHESTRA

Selection from 'Artist's Model'

..... *Jones*

HAYDEN COFFIN

Jack's the Boy (The Geisha)

..... *Sidney Jones*

ORCHESTRA

Selection from 'San Toy'

..... *Jones*

**10.15 MUSIC AND A PLAY**

*S.B. from Liverpool*

(See Liverpool Programme)

**11.0-12.0 DANCE MUSIC:**

JACK HOWARD and his BAND  
from the Royal Opera House,  
Covent Garden



From the photograph by Lieut. Bowers

## CAPTAIN SCOTT AND HIS PARTY ON THEIR RETURN MARCH FROM THE SOUTH POLE.

Mr. H. G. Ponting, who was the official photographer with the Scott Expedition, will tell the heroic story of Captain Scott and his dash to the South Pole.  
[London, 3.0.]

# PROGRAMMES FOR MONDAY (January 17)

## 5IT BIRMINGHAM. 491.8 M.

- 3.45 THE STATION PIANOFORTE QUINTET: Leader, FRANK CASTELL
- 4.45 AFTERNOON TOPICS: SIDNEY ROGERS, 'Horticultural Hints—Kitchen Gardening,' NORAH TARRANT (Contralto)
- 5.15 THE CHILDREN'S HOUR
- 6.0 HAROLD TURLEY'S ORCHESTRA, relayed from Prince's Café
- 6.25 S.B. from London
- 7.45 S.B. from Manchester
- 8.0 S.B. from London (9.10 Local News)

### 9.30-11.0 A LIGHT PROGRAMME

THE STATION ORCHESTRA, conducted by JOSEPH LEWIS

Overture, 'Zampa' ..... *Hérold*

JAMES HOWELL (Baritone) and Orchestra

If Love's Content (Tom Jones) ..... *German*

The Fishermen of England (The Rebel Maid) ..... *German*

ORCHESTRA

Selection, 'The Grand Duchess' .... *Offenbach*

JAMES HOWELL

Droop not, Young Lover ..... *Handel*

The Sweetest Flower That Blows ..... *Haucley*

Good Fellows ..... *Phillips*

HANDEL'S air gives some sturdy advice to the slighted lover, the burden of which is that he should stiffen his back, and determine to pay the disdainful maiden in her own coin. 'Pine not in sadness . . . runs the song. 'If she look coldly . . . slight her again!'

THE message of the second song is an old and a fragrant one:—

The sweetest flower that blows  
I give you as we part,  
For you it is a rose,  
For me it is my heart.

ORCHESTRA

Ballet Music from 'Faust' ..... *Gounod*

### CON CONRAD

(The famous American Composer) in some of his Latest Successes

ORCHESTRA

Suite, 'Americana' ..... *Thurban*

## 6BM BOURNEMOUTH. 326.1 M.

- 3.0 London Programme relayed from Daventry
- 4.30 ORCHESTRAL MUSIC, relayed from the Grand Super Cinema, Westbourne. Directed by ISADORE GODOWSKY
- 5.0 London Programme relayed from Daventry
- 5.15 THE CHILDREN'S HOUR
- 6.0 REGINALD S. MOUAT (Violin Recital)
- Ballade and Refrain Rococo ..... *J. H. Foulds*
- Cradle Song ..... *Tor Aulin*
- From the Canbrake ..... *Samuel Gardner*
- Romance, Op. 30 ..... *Sinding*
- Tambourin Chinois ..... *Kreisler*
- 6.25 S.B. from London
- 7.45 S.B. from Manchester
- 8.0 'THE BLUE PENGUIN'

A Play by HAROLD SIMPSON and GEOFFREY TEMPEST

Played by the LONDON RADIO REPERTORY PLAYERS

Cast:

Mary Fletcher ..... MARGARET GASKIN

Jasper Fletcher (Her Husband, Owner of the Inn and Farm) ..... HENRY OSCAR

David Fletcher (Jasper's Brother)

HARGOURT WILLIAMS

Jacob (Potman at the Inn) ..... FRED GROVE

ON a stormy winter's evening, in the kitchen of a little country inn, 'The Blue Penguin,' Jacob, the old potman, is seated on a settle muttering to himself and gazing into a fire which is burning on a large open fireplace. Through a long, low lattice window at the back of the room, the corner of a porch can be seen.

8.22 THE STATION OCTET, directed by REGINALD S. MOUAT

Fantasia Overture, 'Three Days' ..... *Lotter*

Valse, 'Mon Rêve' ..... *Waldteufel*

Fox-trot, 'Top-Hole' ..... *Hickey*

8.45 S.B. from London (9.10 Local News)

9.30 S.B. from Newcastle

10.15-11.0 S.B. from London

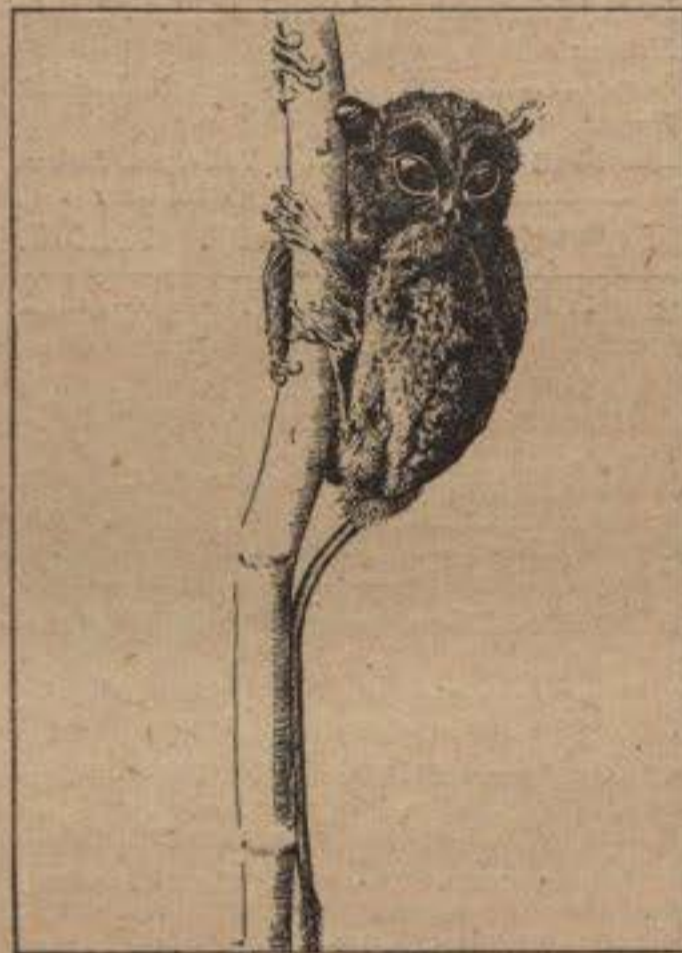

### THE SPECTRAL TARSIER LOOKS BACKWARD.

This curious little creature is the survivor of the nearest known relative of man's earliest primate ancestor—the first to look forward and acquire complete visual control of its movements. It has a wider range of head movements than any other mammal, and affords crucial evidence for the interpretation of how man attained his skill. Listeners will hear all about this strange little animal in Professor G. Elliot Smith's Talk from London at 4.15 to-day. (The illustration is taken from Prof. Elliot Smith's 'Evolution of Man,' Oxford University Press, 1927.)

## 5WA CARDIFF. 353 M.

- 12.30-1.30 Lunch-time Music from the Carlton Restaurant
- 3.15 BROADCAST TO SCHOOLS: Capt. H. A. GILBERT, 'Orkney and Its Birds'
- 3.40 THE STATION TRIO:
- FRANK THOMAS (Violin), FRANK WHITNALL (Violoncello), VERA McCOMB THOMAS (Pianoforte)
- Fantasy, 'Samson and Delilah' .. *Saint-Saëns*
- Violin Solo, 'La Gitana' (The Gipsy)... *Kreisler*
- 4.15 London Programme relayed from Daventry
- 4.30 THE STATION TRIO
- Le Soir (Evening) ..... *Gounod*
- Rosemary ..... *Elgar*

4.45 Mr. F. J. HARRIES, 'Lord Byron and Wales'

5.0 Pianoforte Recital

5.15 THE CHILDREN'S HOUR

6.0 Miss EDITH CEBERVALL, 'Prose Writers of the 19th Century—De Quincey'

6.15 Light Music by the STATION TRIO

6.25 S.B. from London

7.45 S.B. from Manchester

### 8.0 COMEDY AND TRAGEDY

THE STATION TRIO: FRANK THOMAS (Violin), FRANK WHITNALL (Violoncello), VERA McCOMB THOMAS (Pianoforte)

Excerpt, 'Coppélia' Ballet ..... *Delibes*

### 'EMPEROR II'

A Radio Drama by JOHN COOPER

Produced by GORDON McCONNEL

Professor Martin ..... DONALD DAVIES

Scanlon ..... IVOR MADDON

O'Grady ..... SIDNEY EVANS

Watson ..... JOHN DERWENT

IN the dining-room of his house in Regent's Park, Professor Martin is entertaining two fellow anthropologists and zoologists, O'Grady and Scanlon. Dinner is just over. The night is stormy and oppressive. The Professor is talking to Scanlon as the play commences:

TRIO

Tambourine Dance ..... *Dunhill*

### 'THE RED-HAIRED TRAMP'

by D. HUMPHREYS

Produced by GORDON McCONNEL

Mr. Smith ..... SIDNEY EVANS

Mrs. Smith ..... FLOBA McDOWELL

The Visitor ..... DONALD DAVIES

MR. AND MRS. SMITH are breakfasting in their dining-room. Mr. Smith is reading his morning post, which consists chiefly of bills.

TRIO

L'Angroisse ..... *Trenisot*

8.45 S.B. from London (9.10 Local News)

9.30 THE STATION ORCHESTRA, conducted by WARWICK BRAITHWAITE

Scherzo (A Midsummer Night's Dream) ..... *Mendelssohn*

9.35 DAVID BRYNLEY (Tenor)

The Crimson Poppies ..... *Grace Thynne*

The Lake Isle of Innisfree ..... *Angus Morrison*

Yarmouth Fair (Folk Song) .. *arr. Peter Warlock*

9.42 HILARY EVANS (Flute), LEONARD BUSFIELD (Violin), GORDON BRYAN (Pianoforte)

Fifth Brandenburg Concerto (for Solo Flute, Solo Violin and Solo Pianoforte) ... *Brahms*

10.10 ORCHESTRA

Solemn Melody ..... *Walford Davies*

Shepherd's Hey ..... *Grainger*

10.15 DAVID BRYNLEY

The Downs ..... )

Mary and the Kitten ..... ) *Gordon Bryan*

Ariel's Mockery ..... )

Love at First Sight ..... )

Acceptation ..... )

(Accompanied by the Composer)

10.22 GORDON BRYAN

Carillon (Etude d'Execution Transcendante) ..... *Liapounov*

10.30 ORCHESTRA

Overture, 'Jean de Paris' ..... *Baladieu*

(Continued on the next page.)

You can now buy the



**British Farmers Coat  
Direct from the Makers**

for **35/-**

**It is absolutely and  
utterly Waterproof**

Whatever price you pay, there is no better Weathercoat for the protection of Farmers, Game-keepers, Smallholders, Stock Breeders and Dealers; Poultry Farmers, Estate Bailiffs and Factors; Surveyors, Travellers, Insurance Men and all who have to face heavy rains. This "Kelvington" is made by the makers of the "Mattamac" Stormproof.

A good-looking, hard-wearing coat, built to give trusty wear for years under the sternest conditions. Made of heavy double-twill inner-proofed fabric of unusual strength, with careful stitching, leather wristbands and leather skirt binding, reinforced seams and button holes, "bag" pockets, etc. Of generous and easy cut, it is altogether a well-made, smart, serviceable Weatherproof, and an example of outstanding value.



**Direct  
from Maker  
to Wearers**

**35/-**

Post free in British Isles.  
Extra abroad.

A careful comparison with other Coats will prove that style and quality to equal the "KELVINGTON" standard cannot ordinarily be bought for less than 57/6. The reduced price of the "KELVINGTON," showing a value-advantage to the buyer of, roughly, 22/6, is made possible by the changed Policy of selling Direct to the Public only, with a corresponding lessening of selling costs.

**SENT ON 7 DAYS' FREE APPROVAL**

To order a "KELVINGTON": send chest measurement over waistcoat, full height and remittance for 35/- with your name & address, clearly written, to: Pearson Bros., 45 Conduit St. London, W. 1. If you are not thoroughly satisfied with the "KELVINGTON" and return it within 7 days of receipt, Pearson Bros. hereby undertake to refund the full price paid.

**BOOKLET AND PATTERN POST FREE**

You can inspect and try-on the "KELVINGTON" in the "Mattamac" Showrooms at London and Birmingham, or you can safely send your order by post, under the 7 days' free approval plan. If preferred, however, we will send you the Booklet, order form, etc., and a sample of "KELVINGTON" Fabric first. Write to the Sole Makers:—

**PEARSON BROS. Ely House,  
45 Conduit St. London, W.1**

Sole Makers of "Mattamac" & "Kelvington" Coats  
**BRANCHES AT:**

20 Ludgate Hill, London, E.C. (ten doors from St. Paul's)  
117 Oxford St., London, W. (between Dean St. & Wardour St.)  
157 Finchurch St., London, E.C. (two doors from Lime St.)  
129a Victoria St., Westminster, S.W. (2 doors from Ashley Pl.)  
Midland Showrooms: 134 New St. Birmingham

**PROGRAMMES FOR MONDAY (January 17)**

(Continued from the previous page.)

**10.40-11.0 'HALF-AN-HOUR TO SPARE'**

THREE sisters, MARION FOREMAN (a Shakespearean Actress), LILLIAN FOREMAN (known to Cardiff listeners as Lillian Mills), and GWEN FOREMAN (who is also an actress), share a flat. To-night they had arranged to rehearse for a forthcoming recital. A telegram arrives to say that Gwen has missed her train and will be half-an-hour late for the rehearsal. To pass the time Marion and Lillian 'run through' their items.

- LILLIAN  
Catch Me ..... Margaret Cooper-Trotter  
The Queen of Tarts ..... Sterndale Bennett
- MARION  
Garden Scene (Romeo and Juliet)
- MARION and LILLIAN  
Duot. 'Sweet and Low' ..... Barnby
- MARION  
Silver ..... Walter de la Mare
- LILLIAN  
Blue Moon ..... Talbot and Rubens

**2ZY MANCHESTER. 384.6 M.**

3.25 BROADCAST TO SCHOOLS: MR. EDWARD CRESSY, 'Great Canals of the World—Introductory Talk'

3.45 KEEM McENDOO (Solo Violin)  
A Boree ..... 18th Century, arr. A. Moffat  
Almacks, 1795 }  
Prunella ..... Dale  
Poupée Valsante ..... Poldini-Kreiser  
Tempo di Menuetto ..... Puglisi-Kreiser

4.0 Orchestral Music from the Piccadilly Picture Theatre

5.0 AFTERNOON TOPICS: MRS. SELINA COOPER, J.P., 'The Little Things That Worry Us'

5.15 THE CHILDREN'S HOUR: 'The King's Breakfast,' by A. A. Milne and Fraser-Simson  
A Song, with Story and Piano Accompaniment

6.0 THE MAJESTIC 'CELEBRITY' ORCHESTRA from the Hotel Majestic, St. Anne's-on-the-Sea.  
Musical Director: GERALD W. BRIGHT

6.25 S.B. from London

6.45 THE MAJESTIC 'CELEBRITY' ORCHESTRA (Continued)

7.0 S.B. from London

7.45 VOICE AND PERSONALITY—1.  
Special Test conducted by Professor T. H. PRAR (Professor of Psychology, Manchester University)  
(See special article on page 101)

**8.0 VARIETY**

THE ROUGE ET NOIR DANCE BAND  
Fox-trot, 'Lonesome and Sorry'  
Doris and Conrad  
Charleston, 'Static Strut' ..... Yellen and Wall  
One-Step, 'Coontown Chimes' ..... Webster  
A Piano, Some Songs, and EDITH JAMES  
What Does He Call You, Girls? ..... Weston  
His Little Teddy Bear ..... Leycey  
Don't Let Nobody Steal You ..... Weston and Lee

DANCE BAND  
Fox-trot, 'I'm Lonely Without You'  
Warren and Green

Waltz, 'In Love With You' ..... Lennox  
Fox-Trot, 'Lonely Acres' ..... Robinson

EDITH JAMES  
How Many Times? ..... Berlin  
Domestic Tragedy ..... Edith James  
Waiting for Something to Happen ..... Ellis

DANCE BAND  
Red, Red Robin ..... Wood  
Waltz, 'Say That You Love Me' ..... Nicholls

8.45 S.B. from London (9.10 Local News)

**9.30-11.0 FROM THE OPERAS**

FODEN'S MOTOR WORKS BAND, conducted by W. HALLIWELL

Selection from Faust ..... Gounod  
STUART ROBERTSON (Baritone)

As a Father with His Children (Coffee Cantata) ..... Bach

Si, Tra i Ceppi (Berenice) ..... Handel

BAND  
Rigoletto ..... Verdi

ALICE MOXON (Soprano)  
Ah, Lo So (The Magic Flute) ..... Mozart

O Yes, Just So (Phoebus and Pan) ..... Bach

BAND  
Selection from Tannhäuser ..... Wagner

STUART ROBERTSON  
'Qui Sdegno Non' (Who Disdains Not'), from 'The Magic Flute' ..... Mozart

Vulcan's Song from 'Philemon and Baucis' ..... Gounod

ALICE MOXON  
Depuis le Jour ('Since the Day'), from 'Louise' ..... Charpentier

Jewel Song from 'Faust' ..... Gounod

BAND  
Selection from 'I Pagliacci' ..... Leoncavallo

**6KH HULL. 288.5 M.**

11.30-12.30 Gramophone Records

3.30 Light Music

4.0 AFTERNOON TOPICS: Miss K. V. CONI—(6) 'A Dickens Commentary'

4.15 FIELD'S QUARTET, relayed from the New Restaurant, King Edward Street

5.15 THE CHILDREN'S HOUR

6.0 London Programme relayed from Daventry

6.25 S.B. from London

7.45 S.B. from Manchester

8.0 S.B. from London (9.10 Local News)

9.30 S.B. from Newcastle

10.15-11.0 S.B. from London

**2LS LEEDS-BRADFORD. 277.8 M. & 254.2 M.**

4.0 THE LEEDS-BRADFORD LIGHT SYMPHONY ORCHESTRA, relayed from Fenton Street Drill Hall, Leeds, on the occasion of the Yorkshire Post Building Trades Exhibition

5.0 AFTERNOON TOPICS: M. K. DODGSON, 'Humour in Books—(3) Saki'

5.15 THE CHILDREN'S HOUR

6.0 Light Music

6.25 S.B. from London

7.45 S.B. from Manchester

8.0 S.B. from London (9.10 Local News)

9.30 S.B. from Newcastle

10.15-11.0 S.B. from London

**6LV [LIVERPOOL. 297 M.**

11.30-12.30 Gramophone Records

4.0 PATRIZOV and his ORCHESTRA from the Futurist Cinema

5.0 AFTERNOON TOPICS: Dr. C. BUDDEN, 'The Village Church of Old England—(3) The Story of the Font'

# PROGRAMMES FOR MONDAY (January 17)

**5.15 THE CHILDREN'S HOUR**  
**6.0 MONTAGUE'S SYMPHONICS**, relayed from the Edinburgh Café Ballroom  
**6.25 S.B. from London**  
**7.45 S.B. from Manchester**  
**8.0 NAUTICAL PICTURES**  
 THE STATION ORCHESTRA, directed by FREDERICK BROWN  
 Overture, 'Calm Sea and Prosperous Voyage' Mendelssohn  
 GEORGE HILL and THE LIVERPOOL MALE VOICE QUARTET  
 A-Roving ..... } arr. Terry  
 Lowlands Away ..... }  
 Island Jacobite Song .... arr. Kennedy-Fraser  
 The Liverpool Girls ..... arr. Clive Carey  
 ORCHESTRA  
 Suite, 'Nautical Scenes' ..... Percy Fletcher  
 GEORGE HILL and QUARTET  
 Over the Sea to Skye ..... arr. Barratt  
 Fire Down Below ..... arr. Taylor Harris  
 Tom Bowling ..... } arr. T. K. Fell  
 Can't You Dance a Polka? ..... }  
 ORCHESTRA  
 March, 'Admirals All' ..... Hubert Bath  
**8.45 S.B. from London (9.10 Local News)**  
**9.30 Programme S.B. from Daventry**  
**10.15-11.0 MUSIC AND A PLAY**  
*Relayed to Daventry*  
 ORCHESTRA  
 Chant Elégiaque ..... Tchaikovsky  
 'THE FORGE'  
 A Play in One Act by EDWIN LEWIS (First Performances)  
 Presented by EDWARD P. GENN and played by THE LIVERPOOL RADIO PLAYERS  
 Cast :  
 The Hammer  
 Tom Dixon (A Young Forge Hand) PHILIP H. HARPER  
 Amy Bardet (a Factory Girl) PAULINE PARRY  
 Mrs. Dixon (Tom's Mother) MRS. FRED WILKINSON  
 Alf Dixon (Tom's Father, also a Forge Hand) J. P. LAMBE  
 Pete Mayo (a Forge Hand) ..... DAVID WRAY  
 THE scene is the kitchen of a dwelling-house in Hyacinth Court, which is a slum. Over the wall at the end is a heavy forge. It is half-past nine in the evening, and there is a temporary quiet. Tom Dixon, a young forge hand, is reading by the fire, waiting to go on night shift. Strangely enough, it is a volume of the works of Shelley. He is reading aloud.  
 ORCHESTRA  
 Suite, 'Children's Games' ..... Bizet

**5NG NOTTINGHAM. 275.2 M.**  
**3.20 BROADCAST TO SCHOOLS: Mr. A. H. WHIPPLE, Nature Talk**  
**3.45 THE MIKADO CAFÉ ORCHESTRA**, conducted by FREDERICK BOTTOMLEY  
**4.45 MUSIC AND AFTERNOON TOPICS: Mrs. SWINNEKTON, 'Romance in Botany'**  
**5.15 THE CHILDREN'S HOUR**  
**6.15 MABEL HODGKINSON (Pianoforte)**  
**6.25 S.B. from London**  
**7.45 S.B. from Manchester**  
**8.0 S.B. from London (9.10 Local News)**  
**9.30 S.B. from Newcastle**  
**10.15-11.0 S.B. from London**

**5PY PLYMOUTH. 400 M.**  
**11.0-12.0 GEORGE EAST and his QUARTET** relayed from Popham's Restaurant  
**3.30 Orchestra** relayed from Popham's Restaurant  
**4.0 Afternoon Topics**  
**4.15 TEA-TIME MUSIC: THE ROYAL HOTEL TRIO**, directed by ALBERT FULLBROOK  
**5.15 THE CHILDREN'S HOUR**  
**6.0 WINIFRED STOAKES (Contralto)**  
**6.25 S.B. from London**  
**7.45 S.B. from Manchester**  
**8.0 S.B. from London (9.10 Local News)**  
**9.30 S.B. from Newcastle**  
**10.15-11.0 S.B. from London**



CON CONRAD,

the American composer of 'Mercenary Mary,' who is making a 'tour' of several stations this week, and will entertain Birmingham listeners at 10.30 this evening with some of his most recent song-successes.

**6FL SHEFFIELD. 272.7 M.**  
**11.30-12.30 Gramophone Records**  
**4.0 Afternoon Topics**  
**4.15 Orchestra** relayed from the Grand Hotel  
**5.15 THE CHILDREN'S HOUR: 'For the Little Ones'; Songs, Stories and Music about Your Toys**  
**6.0 Musical Interlude**  
**6.25 S.B. from London**  
**7.45 S.B. from Manchester**  
**8.0 S.B. from London (9.10 Local News)**  
**9.30 S.B. from Newcastle**  
**10.15-11.0 S.B. from London**

**6ST STOKE. 288.5 M.**  
**3.0 London Programme** relayed from Daventry  
**5.0 AFTERNOON TOPICS: JEAN WHITFORD, A Dialogue, 'All Imagination'**

**5.15 THE CHILDREN'S HOUR**  
**6.0 Light Music**  
**6.25 S.B. from London**  
**7.45 S.B. from Manchester**  
**8.0 S.B. from London (9.10 Local News)**  
**9.30 S.B. from Newcastle**  
**10.15-11.0 S.B. from London**

**5SX SWANSEA. 288.5 M.**  
**3.0 London Programme** relayed from Daventry  
**4.30 THE CASTLE CINEMA ORCHESTRA and ORGAN MUSIC**, relayed from the Castle Cinema  
**5.0 Afternoon Topics**  
**5.15 THE CHILDREN'S HOUR**  
**6.0 EVELYN DAVIES-HOWELLS (Contralto)**  
 Where Corals Lie ..... Elgar  
 Ombra Mai Fu (The Largo) ..... Handel  
 Che Faro ('What shall I do?') ..... Gluck  
 Bedd y Dyn Tylawd ..... V. Thomas  
 A Song of Exile ..... May Brahe  
**6.25 S.B. from London**  
**7.45 S.B. from Manchester**  
**8.0 S.B. from London (9.10 Local News)**  
**9.30 S.B. from Newcastle**  
**10.15-11.0 S.B. from London**

## Northern Programmes.

**5NO NEWCASTLE. 312.5 M.**  
**3.0:—London programme** relayed from Daventry. **3.30:—Mr. Edgar L. Bainton, 'Descriptive Music' (1).** **4.0:—Music from Coxon's New Gallery Restaurant.** **5.0:—London Programme** relayed from Daventry. **5.15:—Children's Hour.** **6.0:—Linda Seymour (Contralto).** **6.25:—S.B. from London.** **7.45:—S.B. from Manchester.** **8.0:—Station Octet; Eda Benke (Soprano).** **8.45:—S.B. from London.** **9.30:—Station Octet: Overture, 'The Barber of Seville' (Rossini).** **9.40:—Admiral Peters, A Comedy in One Act, by W. W. Jacobs and Horace Mills.** Presented by Eric Barber and played by the Station Repertory Company. **10.0:—Octet; George Tindle (Bass-Baritone).** **10.25:—Harton Colliery Band Brass Quartet, conducted by Ernest Thorpe. Overture, 'Les Huguenots' (Meyerbeer); Selection, 'The Bohemian Girl' (Balfe, arr. Küssner); Remembrance (Round). **10.40:—George Tindle: Long A2 in Alesia (Messenger); Harlequin (Sanderson); The showman (W. James). **10.50-11.0:—Quartet: Overture, 'William Tell' (Rossini); Clouds and Sunshine (H. Round).******

**5SC GLASGOW. 405.4 M.**  
**3.0:—Dance Music**, relayed from the Pleadilly Dance Club. **4.0:—Wireless Quartet: Margaret B. Scott (Soprano).** **5.0:—Afternoon Topics: B. G. Aston, 'The Gods of the Ancient Egyptians.'** **5.15:—Children's Hour.** **5.58:—Weather Forecast for Farmers.** **6.0:—Dance Music**, relayed from the Pleadilly Dance Club. **6.30:—S.B. from London.** **7.45:—S.B. from Manchester.** **8.0:—S.B. from London.** **9.30-11.0:—'The Gentle Shepherd,' a Pastoral Play, by Allan Ramsay.**

**2BD ABERDEEN. 500 M.**  
**11.0 a.m.-Noon:—Gramophone Records.** **3.45:—Dance Music.** Played by John R. Swensen and his New Toronto Band. Relayed from the New Palais de Danse. **4.15:—Afternoon Topics.** **4.30:—Dance Music (Continued).** **5.15:—Children's Hour: Music by the Wireless Orchestra.** **6.0:—The Station Orchestra.** **6.30:—S.B. from London.** **7.45:—S.B. from Manchester.** **8.0:—Station Orchestra. Toplis Green (Baritone).** **8.45:—S.B. from London.** **9.30:—Short Classical Programme; Station Orchestra. Cisle Woodward (Pianoforte). Toplis Green (Baritone).** **10.15-11.0:—S.B. from London.**

**2BE BELFAST. 306.1 M.**  
**3.0:—Broadcast to Schools: Prof. James Small (Professor of Botany, Queen's University), 'What Botany Really Means.'** **4.0:—Station Orchestra.** **4.30:—Margaret Huxley (Solo Violin).** **4.42:—Orchestra.** **5.0:—Afternoon Topics: Herbert T. Scott and May Shepherd, 'Some Songs Worth Singing and Why.'** **5.15:—Children's Hour.** **6.0:—Station Dance Band.** **6.25:—S.B. from London.** **7.45:—S.B. from Manchester.** **8.0:—Belfast Radio Quartet: Elizabeth Lewis (Soprano); Sydney Northcote (Tenor).** **8.45:—S.B. from London.** **9.30:—Request, Station Orchestra: Overture, 'La Dame Blanche' (Boisdebut); Selection, 'Merrle England' (E. German). Evva Kerr (Soprano): 'Tis the Last Rose of Summer (Trad.); By the Waters of Minnetonka (Licence); You Don't Believe in Fairies (B. Hope).** **9.58:—Orchestra: Selection, 'Lilac Time' (Schubert-Cutsum). H. Hooten Mitchell (Baritone): Thoughts Have Wings (I. Lehmann); Shipmates o' Mine (W. Sanderson); The Trumpeter (J. A. Dix). Orchestra: Intermezzo (Cavalleria Rusticana) (Mascagni); Waltz, 'The Blue Danube' (Strauss). **10.30-11.0:—S.B. from London.****

# PROGRAMMES FOR TUESDAY (January 18)

## 2LO LONDON. 361.4 M.

- 1.0-2.0 Concert by the J. H. SQUIRE CELESTE OCTET
- 3.0 Broadcast to Schools: Sir H. WALFORD DAVIES, 'Elementary Music'
- 4.0 TIME SIGNAL, GREENWICH. WILLIAM HODGSON'S MARBLE ARCH PAVILION ORCHESTRA, from the Marble Arch Pavilion.
- 5.0 Topical Talk
- 5.15 THE CHILDREN'S HOUR: Songs by MAVIS BENNETT. 'Brothers of the Band; The Viola and the Double Bass,' by V. HELY HUTCHINSON. 'The Treasure of San Rosario,' by E. LE BRETON MARTIN.
- 6.0 Miss CAIRD LOTHIAN reading a darkie story: 'The Eyes of the Wise Old Owl'
- 6.10 THE LONDON RADIO DANCE BAND, directed by SIDNEY FIRMAN
- 6.30 WEATHER FORECAST, FIRST GENERAL NEWS BULLETIN
- 6.45 THE LONDON RADIO DANCE BAND, directed by SIDNEY FIRMAN
- 7.0 Topical Talk
- 7.15 THE FOUNDATIONS OF MUSIC  
Bach's 48 Preludes and Fugues, played through consecutively at this hour daily throughout the month
- 7.25 Prof. P. J. NOEL BAKER: 'Foreign Affairs and how They affect Us. What are Foreign Affairs?'

THIS is the first of six Talks, designed to explain to the general public the obscure but fascinating subject of Diplomacy. Professor Noel Baker, who is now Professor of International Relations in the University of London, worked on the League of Nations Secretariat from the Peace Conference until 1922, and wrote the standard book on the Geneva Protocol of 1925.

- 7.45 R. A. ROBERTS in 'DICK TURPIN'
- Characters:
- Jacob Sly (a Bow Street runner)
  - Soft Sally (the Innkeeper)
  - Jerry Binks (a Yorkshire Farmer)
  - Lady Maud Romander
  - Dick Turpin

Every Character in this sketch will be acted by the Author, R. A. ROBERTS  
Incidental Music by Herman Finck

MR. ROBERTS owes his reputation as a protean actor not merely to his abilities as a quick-change artist, but to his power of changing his whole personality, including, of course, his voice, with each new part that he assumes. This sketch, in which he takes all five parts, is a particularly good illustration of his art.

- 8.20 app. JOSEPHINE TRIX
- 8.45 THROUGH ANOTHER'S EYES  
Played by ADOLPHE HALLIS
- GERMANY (as seen by a Frenchman)  
'Uncle Gottfried' (Dialogue between John Christopher and Gottfried, from Romain Rolland's Novel 'John Christopher' Paul Dupin)
- SPAIN (as seen by a Frenchman)  
'Alborada dal Gracioso' (Don Juan's Morning Serenade) ..... Ravel

THE passage upon which the first piece is based occurs towards the end of the first part of *John Christopher*—that entitled *The Dawn*. One evening about sunset Christopher has followed the poor pedlar, Uncle Gottfried, to the river bank, and is much moved by a song that the pedlar sings.

Romain Rolland's description runs thus (in Gilbert Cannan's translation, published by Heinemann, :-

Suddenly, in the dark, Gottfried began to sing. He sang in a weak, husky voice, as though to himself; he could not have been heard twenty yards away. But there was sincerity and emotion in his voice; it was as though he were thinking aloud, and that through the song, as

through clear water, the very inmost heart of him was to be seen. Never had Christopher heard such singing, and never had he heard such a song.

Then the boy and the man discussed the making of songs; the lad, full of dreams of greatness, wanted to write songs himself and become famous. The man replied:—

'The more you want to, the less you can. To make songs, you have to be like those creatures. Listen . . . .'

The moon had risen, round and gleaming, behind the fields. A silvery mist hovered above the ground and the shimmering waters. The frogs croaked, and in the meadows the melodious fluting of the toads arose. The shrill tremolo of the grasshoppers seemed to answer the twinkling of the stars. The wind rustled softly in the branches of the alders. From the hills above the river there came down the sweet light song of a nightingale. . . .



Mr. R. A. ROBERTS.

London listeners will to-night hear Mr. R. A. Roberts, the protean quick-change artist, in the sketch 'Dick Turpin,' in which he takes all five parts. Mr. Roberts is broadcasting at 7.45.

Paul Dupin (born 1865) has clearly sought to suggest sympathetically in his music the older world of music that Uncle Gottfried loved—the music of simple sentiment that appeals directly to the heart.

MANY a Composer has been lured by those Spanish and Italian love-songs, 'serenades,' sung at night-time by love-sick swains, playing their Guitars beneath their ladies' windows. Here is a morning love-song, an 'Alborada' or 'Aubade.' It is sung by that gentleman with the untranslatable name—'El Gracioso.' He has been called 'The jester,' and 'The buffoon,' but neither name does him justice; for this characteristic Spanish mixture of wit and gallantry is subtle, delicate, refined.

Ravel's character-sketch is one of five Piano Pieces, *Reflexions (Miroirs)*.

- 9.0 WEATHER FORECAST, SECOND GENERAL NEWS BULLETIN; Local Announcements

- 9.15 Sir H. WALFORD DAVIES: 'The Mind of Beethoven: His Note Values'

- 9.35 CONCERT  
Relayed from the NEW CHENIL GALLERIES  
THE CHENIL CHAMBER ORCHESTRA, conducted by JOHN BARBIROLI  
Solo Pianoforte, RAE ROBERTSON  
Concerto for Piano and Orchestra, No. 2, in F Minor ..... Chopin  
Maestoso; Larghetto; Vivace  
(Soloist, RAE ROBERTSON)

- On Hearing the First Cuckoo in Spring . . . Debuss
- Romantic Overture for Chamber Orchestra  
Arnold Bax  
(First Performance)

(At the Piano, RAE ROBERTSON)

- Symphony, No. 36, in C, K425 ..... Mozart  
Adagio—Allegro spiritoso; Poco Adagio;  
Menuetto; Presto

- 10.30-12.0 DANCE MUSIC: KETTNER'S FIVE under the direction of GEOFFREY GELDER and DEMOS, from Kettner's Restaurant.

## 5XX DAVENTRY. 1,600 M.

- 10.30 a.m. TIME SIGNAL, WEATHER FORECAST
- 11.0 THE DAVENTRY QUARTET and DEO MANN (Mezzo-Soprano), DANIEL HUNT (Cornet), CON INGHAM (CORN SONGS), MAY MOORE DUTREZ
- 1.0-2.0 S.B. from London
- 3.0 S.B. from London
- 7.0 Miss L. RAMSAY: 'Building a Village Hall'
- 9.10 Shipping Forecast
- 9.15-12.0 S.B. from London

## 5IT BIRMINGHAM. 491.3 M.

- 3.45 BROADCAST TO SCHOOLS: Mr. W. A. SUMMERS, 'Boys in Tales of Adventure—(1) Huckleberry Finn'
- 4.15 Lozells Picture House Orchestra
- 4.45 AFTERNOON TOPICS: C. A. VINCE, 'Landmarks in the History of Birmingham—The Library.' (The First of a Series of Talks arranged in connection with the Birmingham Library.)  
MARJORIE HOVERD (Soprano)
- 5.15 THE CHILDREN'S HOUR
- 6.0 HAROLD TURLEY'S ORCHESTRA, relayed from Prince's Café
- 6.30 S.B. from London
- 7.0 M. EUGÈNE DE GYN, 'Beneath Italian Skies'
- 7.15 S.B. from London (9.10 Local News)

## 9.35 BALLAD CONCERT

- TOM KINNIBURGH (Bass)  
Myself When Young (from 'In a Persian Garden')  
Lehmann
- The Song of Hybrias the Cretan ..... Elliott
- GLADYS WARD (Dramatic Recital with Music)  
The Castle By the Sea (Translated by Alfred Kalch) (Music by Richard Strauss)  
Lorraine-Lorree (Words by Charles Kingsley)  
(Music by Stanley Hawley)
- SOPHIE ROWLANDS (Soprano)  
Air de Lia (from 'L'Enfant Prodigue')... Debussy  
Do You Remember? ..... Souverville
- TOM KINNIBURGH  
The Sea Road ..... Wood  
Fairings ..... Easthope Martin  
Royster Doyster ..... Matheson
- W. A. CLARKE (Bassoon)  
Tytolean Theme and Variations .... Standhaft
- SOPHIE ROWLANDS  
Romance (from 'Cavalleria Rusticana')  
Mascagni
- Just You ..... Burleigh
- Songs My Mother Taught Me ..... Dvorak
- 10.30-12.0 S.B. from London



# PROGRAMMES FOR TUESDAY (January 18)

## CBM BOURNEMOUTH. 326.1 M.

11.30-12.0 ARTHUR MARSTON, ORGAN RECITAL, relayed from the Royal Arcade, Boscombe

Tempo di Marcia (Sonata 7) ..... *Gaillard*  
Meditation ..... *Dubois*  
Sonata No. 4 ..... *Mendelssohn*  
Allegro con brio; Andante Allegretto; Allegro  
maestoso

3.0-3.30 London Programme relayed from Daventry

4.0 TEA-TIME MUSIC from Beale's Restaurant, Old Christchurch Road. Directed by GILBERT STACEY

March, 'The Thin Red Line' ..... *Alford*  
Three Dances (Henry VIII.) ..... *German*  
Selection, 'The Student Prince' ..... *Romberg*  
Song Waltz, 'Always' ..... *Berlin*  
Londonderry Air ..... *Coleman*  
Selection, 'Tip-Toes' ..... *Gershwin*  
Songs ('Beneath Thy Window' ..... *Di Capua*  
'When the Sergeant-Major's on Parade' ..... *Longstaffe*

Cavatina ..... *Raff*  
Fox-trot, 'The More We Are Together' .. *King*

5.0 London Programme relayed from Daventry

5.15 THE CHILDREN'S HOUR

6.5 For Farmers: Mr. J. P. HARDING, 'The Marketing of Eggs and Poultry'

6.30 S.B. from London

7.0 Major C. EAGLE-BOTT, 'The Ghost-Light'

7.15-12.0 S.B. from London (9.10 Local News)

## 5WA CARDIFF. 353 M.

3.0 London Programme relayed from Daventry

3.30 THE STATION TRIO: FRANK THOMAS (Violin), FRANK WHITNALL ('Cello), VERA McCOMB THOMAS (Piano)

Lyric Valse ..... *Sibelius*  
Rêverie ..... *MacDowell*  
Evensong ..... *Easthope Martin*  
Two Syncopated Pieces ..... *Coates*

4.15 TEA-TIME MUSIC from the Carlton Restaurant

4.45 Miss ELSPETH SCOTT, 'Credulity'

5.0 TEA-TIME MUSIC (continued).

5.15 THE CHILDREN'S HOUR

6.0 Mr. T. J. LEWIS, 'The Wonder of Photography'

6.10 BEETHOVEN SONATA

No. 2, in A Major, for Violin and Pianoforte (Solo Violin, LEONARD BUSFIELD)  
(Solo Pianoforte, VERA McCOMB THOMAS)

THIS early work (it was published when Beethoven was twenty-nine) has little of solemnity and nothing of heaviness.

Its FIRST MOVEMENT is gay, Spring-like music—fresh and exhilarating.

The SECOND MOVEMENT, though slower and more meditative, is but an interlude of homely chat between friends. There is here no spirit of 'Ah, things aren't what they were.' Rather do we imagine two people, who understand each other's hopes and aims, discussing the future in quietly optimistic mood.

The THIRD MOVEMENT (the last) is again happy, in a care-free style. It is built on three Main Tunes, the first of which has a touch of syncope in it. The Second (Pianoforte and Violin together, in octaves, very quietly) has the simplicity of a country dance. The Third (Violin) is song-like. One feels it ought to have words.

6.30 S.B. from London

7.0 Mr. RICHMOND KELLYAR, 'Humour of the Film—LARRY SEMON, BUSTER KEATON, SYD CHAPLIN'

7.15-12.0 S.B. from London (9.10 Local News)

## 2ZY MANCHESTER. 384.6 M.

1.15-2.0 TUESDAY MIDDAY SOCIETY'S CONCERT, relayed from the Houldsworth Hall. Pianoforte Recital by FRANK MERRICK

3.0 London Programme relayed from Daventry

3.30 AFTERNOON MUSIC: J. MEADOWS (Auto-Piano Recital)

3.45 Music by THE STATION QUARTET Selection, 'The Rose' ..... *Myddleton*



Mr. Alfred Barker and Miss Doris Woodcock, two artists whom Manchester listeners will hear to-day. Mr. Alfred Barker will give a short violin recital [10.0], while Miss Doris Woodcock, contralto, will sing during the Tea-Time Concert [4.35]

Berceuse de Jocelyn ..... *Godard*  
Romantic Suite ..... *Stanley*

4.15 BROADCAST TO SCHOOLS (For Secondary Schools): Prof. F. E. WEISS, 'The Romance of Plant Life—(1) The Most Primitive Plants'

4.35 TEA-TIME CONCERT

THE STATION QUARTET  
Waltz, 'Elfin Dances' ..... *Gungl*

DORIS WOODCOCK (Contralto)  
My Prayer ..... *W. H. Squire*

Flower Song ..... *Gounod*

QUARTET  
Selection, 'Queen High' ..... *Gensler*

DORIS WOODCOCK  
At Dawning ..... *Culman*

Vale ..... *Russell*

QUARTET  
March, 'The Gladiator's Farewell' *Blankenberg*

5.15 THE CHILDREN'S HOUR: Scottish Music by THE SUNSHINE TRIO. Two Famous Scots Songs: 'Callie Herrin'; 'By the Bonny, Bonny Banks o' Loch Lomond'

6.0 THE MAJESTIC 'CELEBRITY' ORCHESTRA, from the Hotel Majestic, St. Anne's-on-the-Sea. Musical Director, GERALD W. BRIGHT

6.30 S.B. from London

6.45 THE MAJESTIC 'CELEBRITY' ORCHESTRA (Continued)

7.0 Prof. W. L. BRAGG, 'What Is Scientific Research?' (2)

7.15 S.B. from London (9.10 Local News)

9.35 FOUR SHORT RECITALS.

CHARLES BIRTLES (Solo Trumpet)  
Air with Variations 'Facilita' ..... *Hartmann*  
Fantasia on Weber's 'Last Thought' ..... *Fuchs*

9.45 CON CONRAD  
(The Famous American Composer)  
In Some of his Latest Successes

10.0 ALFRED BARKER (Solo Violin)  
Chanson-Meditation ..... *Cottet*  
Bird as Prophet ..... *Schumann*  
Waltz ..... *Hummel*  
Hungarian Dance ..... *Rachmaninov*

10.15 PARRY JONES (Tenor)  
The Cloths of Heaven ..... *Dunhill*  
To Me at my Fifth Floor Window ..... *Mallinson*  
Crabbed Age and Youth ..... *Parry*  
So Sweet Is She ..... *arr. Bairstow*  
Cuttin' Rushes ..... *Stanford*  
A Prayer To Our Lady ..... *Ford*

10.30-12.0 S.B. from London

## 6KH HULL. 288.5 M.

4.0 AFTERNOON TOPICS: Mrs. J. REDWOOD ANDERSON, 'Art Through the Ages—(1) Pre-historic and Primitive Art'

4.15 FIELD'S QUARTET, relayed from the New Restaurant, King Edward Street

5.15 THE CHILDREN'S HOUR

6.0 London Programme relayed from Daventry

6.15 Beverley and District Bee Keepers' Association Monthly Talk

6.30-12.0 S.B. from London (9.10 Local News)

## 2LS LEEDS-BRADFORD. 277.8 M. & 254.2 M.

4.0 WYNN AND ALLAN'S ALL STAR VERSATILES, relayed from Schofield's Café, Leeds

5.0 Afternoon Topics

5.15 THE CHILDREN'S HOUR

6.0 Light Music

6.30 S.B. from London

7.0 THE SMILESMITH, 'On My Anvil'

7.15-12.0 S.B. from London (9.10 Local News)

## 6LV LIVERPOOL. 297 M.

4.0 Talk for Women by MURIEL LEVY

4.15 A. C. WARD (Baritone)  
I Pitch My Lonely Caravan ..... } *Eric Coates*  
The Fairy Tales of Ireland ..... }  
Echo ..... *Lord Henry Somerset*  
The Little Irish Girl ..... *Hermann Lühr*

4.30 THE STATION PIANOFORTE QUARTET

5.15 THE CHILDREN'S HOUR

6.0 THE STATION PIANOFORTE QUARTET

6.30 S.B. from London

7.0 Mr. ERNEST EDWARDS ('Bee'): Sports Talk

7.15-12.0 S.B. from London (9.10 Local News)

## 5NG NOTTINGHAM. 275.2 M.

11.30-12.30 Morning Concert relayed from Daventry

3.45 LYONS' CAFE ORCHESTRA, conducted by BRASSEY EYTON

4.45 MUSIC and AFTERNOON TOPICS

5.15 THE CHILDREN'S HOUR

# This Plan Will Bring You £250 A YEAR FOR LIFE—FROM AGE 55

Ninety-nine men out of a hundred have to provide for their own future. They have no rich relative to take the burden from their shoulders, and no business pension scheme to fall back upon. They stand or fall on their own efforts.

Are you satisfied with the progress you yourself are making? Have you saved anything like enough to justify a belief that at 55 years of age you will be in a position to take things easier? What about your family, should you, the bread winner, be taken from them? The plan about to be explained will, if adopted without further delay, relieve you of all anxiety about the matter.

It is the best, the easiest, and the surest way of providing both for your own later years and for your dependents.

Assuming your age to be 35 and you would like to provide for a private income of £250 a year for life commencing at 55, this is how the plan works out. You make yearly or half-yearly deposits to the Sun Life of Canada (the great Annuity Co.) of an agreed sum. And this is what you will get in return.

### £250 a Year for Life.

At 55 years of age the Sun Life of Canada will start paying you an income for life of a fixed sum—about £250 per annum—and you'll receive this income every year as long as you live. Or, if you prefer it, you can have a cash sum down of about £5,000. Of course, you haven't deposited anything like that sum. It's the profits that make it so large—profits heaped upon profits, accumulated over the entire period of the arrangement.

### Income Tax Saved.

For every deposit you make you receive rebate of Income Tax—a concession which will save you nearly £250 during the period, assuming the present rate of tax to continue. This is additional profit on the transaction.

### £20 a Month if unable to Work.

If through illness or accident you lose the power to earn a living, and the disability is permanent, you are excused from making any further deposits and £20 per month will be paid to you until the £250 a year for life becomes due.

### £2,000 for Your Family.

Should you not live to the age of 55, £2,000 will be paid to your family, and, in addition, half of every deposit you had made to date. If death result from an accident, the sum would be increased to £4,000 plus half the deposits.

### Any Age, Any Amount.

Though 55, and £250 a year for life has been quoted here, the plan applies at any age and for any amount. Whatever your income, if you can spare something out of it for your and your family's future, this plan is the best and most profitable method you can adopt.

### £62,000,000 Assets.

The Sun of Canada has assets of over £62,000,000, which are under Government supervision. It is in an impregnable position. Do not, therefore, hesitate to send for particulars of this plan, which may mean great things for you and yours.

## FILL IN AND POST THIS FORM TO-DAY

To J. F. JUNKIN (Manager),  
SUN LIFE ASSURANCE CO. OF CANADA,  
12, Sun of Canada House, Victoria Embankment,  
London, W.C.2 (near Temple Station).

Assuming I can save and deposit £..... per.....  
please send me—without obligation on my part—full  
particulars of your investment plan showing what incomes  
or cash sum I shall receive in..... years (15, 20, 25,  
30, as desired).

Exact date of birth.....

Married or about to be married.....

Occupation.....

Name.....

Address.....

E.T.

# PROGRAMMES FOR TUESDAY (January 18)

6.15 MABEL HODGKINSON (Pianoforte)

6.30 S.B. from London

7.0 'ASKARI'—'The Uganda Railway'

7.15-12.0 S.B. from London (9.10 Local News)

5PY PLYMOUTH. 400 M.

11.0-12.0 GEORGE EAST and his QUARTET, relayed from Popham's Restaurant

3.30 ORCHESTRA relayed from Popham's Restaurant

4.0 Afternoon Topics

4.15 TEA-TIME MUSIC: THE ROYAL HOTEL TRIO, directed by ALBERT FULLBROOK

5.15 THE CHILDREN'S HOUR

6.0 MARJORIE ASPLIN (Soprano and Pianoforte)

6.30 S.B. from London

7.0 Mr. F. S. RUSSELL, of the Marine Biological Association's Laboratory, 'Life on the Sea Bottom'

7.15-12.0 S.B. from London (9.10 Local News)

6FL SHEFFIELD. 272.7 M.

4.0 AFTERNOON TOPICS: Miss KIRKE, 'Careers for Girls'

4.15 London Programme relayed from Daventry

5.15 THE CHILDREN'S HOUR: More About Ships

6.0 Musical Interlude

6.30 S.B. from London

7.0 The Rev. G. J. JORDAN, 'Messages from the Poets'—(6) Lowell'

7.15-12.0 S.B. from London (9.10 Local News)

6ST STOKE. 288.5 M.

3.0 London Programme relayed from Daventry

5.0 Afternoon Topics

5.15 THE CHILDREN'S HOUR

6.0 Light Music

6.30-12.0 S.B. from London (9.10 Local News)

5SX SWANSEA. 288.5 M.

11.30-12.30 Gramophone Records

3.0 London Programme relayed from Daventry

4.0 THE CASTLE CINEMA ORCHESTRA and Organ Music, relayed from the Castle Cinema

4.30 THE STATION TRIO: T. D. JONES (Piano), MORGAN LLOYD (Violin), GWILYM THOMAS (Cello)

5.15 THE CHILDREN'S HOUR: Music by THE STATION TRIO

6.0 ORGAN RECITAL

relayed from ST. MARY'S PARISH CHURCH  
Organist: A. CYRIL BAYNSHAM  
EDOUARD BATISTE (1820-1876)  
Toccata in B Minor  
Angelic Voices (Two Pieces)  
In A Flat; in E Flat

Carillon  
Chanson  
Andante in G  
Grand Offertoire, in D Minor

EDOUARD BATISTE was one of the most noted French Organists of his time, and a composer of much melodious and light organ music, which has enjoyed great popularity, but which is regarded as representing somewhat imperfectly his real powers as a musician. He was Organist of St. Eustache, Paris

6.30 S.B. from London

7.0 Mr. CRAWFORD HERON, 'The Romance of South Wales Industries'—(2) Fishing'

7.15-12.0 S.B. from London (9.10 Local News)

## Northern Programmes.

5NO NEWCASTLE. 312.5 M.

11.30.—Muriel Stewart (Soprano). 11.40.—William Bell (Cornet). 11.50.—Muriel Stewart. 12.0.—William Bell. 12.10-12.30.—Gramophone Records. 3.0-3.30.—London Programme relayed from Daventry. 4.0.—The Station Octet. 4.15.—Maud Greener (Soprano). 4.25.—Octet. 4.40.—Maud Greener. 4.50.—Octet. 5.0.—London Programme relayed from Daventry. 5.15.—The Children's Hour. 6.0.—The Station Octet. 6.30.—S.B. from London. 7.0.—Dialogue by 'The Gentleman in a Fluster'; 'Regretting the Lost Art of Vituperation.' 7.15-12.0.—S.B. from London.

5SC GLASGOW. 405.4 M.

11.30-12.30.—Gramophone Records. 3.0.—London Programme relayed from Daventry. 3.30.—Dance Music, relayed from the Plaza. 5.0.—Afternoon Topics: Evelyn Smith, 'Types in Fiction'—The New Woman.' 5.15.—The Children's Hour. 5.58.—Weather Forecast for Farmers. 6.0.—Dance Music, relayed from the Plaza. 6.30.—S.B. from London. 7.0.—Mr. Marshall Heath, 'Big Ben Talks to Scotland—Big Ben and Youth.' 7.15.—S.B. from London. 9.30.—Cissie Woodward (Pianoforte): Prelude and Fugue (Arne); Impromptu (Schubert); Dance of the Guineses (Liszt). 9.45.—William McCulloch (Entertainer): Dramatic Recital, 'Through the Flood' (Jan MacLaren). 10.0.—Cissie Woodward: To the Moon (Five Idylls) (Swinstead); Toccata (Gustav Hobst); Dance of the Elves (Frederick Moore); The Musical Box (Cissie Woodward); Idylle (Cissie Woodward); Palabra (Impressions, No. 1) (Leo Livens). 10.15.—William McCulloch: Humorous Recital, 'Mrs. Montgomerie's Wee Shop' (Original). 10.30.—Dance Music, relayed from the Plaza. 11.15-12.0.—S.B. from London.

2BD ABERDEEN. 500 M.

3.45.—Afternoon Topics: Miss Marion Angus, 'Dramatic Moments in History.' 4.0.—The Station Orchestra. 4.20.—Jean Low (Contralto). 4.30.—Orchestra. 4.50.—Jean Low. 5.0.—Orchestra. 5.15.—The Children's Hour. 6.0.—Music by the Wireless Orchestra. 6.30.—S.B. from London. 7.0.—S.B. from Glasgow. 7.15.—S.B. from London. 9.30.—'Così Fan Tutte' (or, 'Tit for Tat'). A Comic Opera by Mozart. Conducted by Arthur Collingwood. Cast: Isidora, Joan Elwes (Soprano); Dorabella, Mrs. Maud Pennington (Soprano) and Alice M. Pettes (Soprano); Despatch, Constance Soutar (Soprano) and Lena Dunn (Contralto); Ferrando, Alexander McCrestie (Tenor); Gratiano, Robert Watson (Baritone); Don Alfonso, Hector Monro (Baritone). The Aberdeen Station Operatic Choir and Orchestra: Leader of Orchestra, Alex Madisky. 11.0-12.0.—S.B. from London.

2BE BELFAST. 306.1 M.

11.0-1.0.—Morning Concert, relayed from Daventry. 3.0.—London Programme relayed from Daventry. 4.0.—Northern Music. The Station Orchestra. 4.30.—Herbert Porter (Baritone). 4.42.—The Station Dance Band. 5.0.—Afternoon Topics: Miss H. Edith Gregg, 'The Cinema Habit.' 5.15.—The Children's Hour. 6.0.—The Station Orchestra. 6.30.—S.B. from London. 7.0.—Mr. J. A. S. Stendall, 'Spiderland' (2). 7.15.—S.B. from London. 9.30.—Irish Comedy. The Station Orchestra: Fantasia on Irish Airs, 'Erin' (Busquet); Valse, 'Irish Whispers' (Ancliffe). 9.47.—'The Shadow of the Glen.' A One Act Comedy by J. M. Synge. Presented by H. Richard Hayward, Dan Burke (a Farmer and Herd), James Stewart; Norah Burke (His Wife), Ethna Hayward; Michael Dara (a Young Herd), Jack Gavin; a Tramp, H. Richard Hayward. 10.15.—Orchestra: Two-step, 'The Blarney Stone' (Engleman); Two Irish Dances (Finocane); Medley March, 'Irish Dragoons' (P. de Ville). 10.30.—Dance Music. Fred Rogers's Dance Band, relayed from the Belfast Boat Club Dance in the Carlton Ballroom: Fox-trots—Hard to Get Gertie (J. Yellen); My Outey's Due at Two-to-Two To-day (A Von Tiler); I'm Lonely Without You (H. Warren); Out in the New Mown Hay (W. Tracey); Slippery Fingers (H. Steele). Waltzes—Just a Rose in Old Killarney (F. Swain); I'm So Terribly in Love with You (V. Ellis); Fox-trot, 'The More We Are Together' (L. King); One-step, 'On the Riviera' (P. Van Looid). Fox-trots—Chinese Moon (J. Nausbaum); For My Sweetheart (W. Donaldson); Somebody's Lonely (B. Davis). 11.0-12.0.—S.B. from London.

# PROGRAMMES FOR WEDNESDAY (January 19)

**2LO LONDON. 361.4 M.**

1.0-2.0 CAMILLE COUTURIER'S ORCHESTRA from Restaurant Frascati

3.0 BROADCAST TO SCHOOLS: Mr. A. LLOYD JAMES, 'Our Native Tongue'

MR. LLOYD JAMES was secretary to the B.B.C.'s Advisory Committee of experts on spoken English which recently drew up, for the benefit of Announcers, a list of the pronunciations that they were to use for certain doubtful words. He will give a series of twelve Talks during this season, of which this is the first.

3.20 Mr. J. C. STOBART and Miss MARY SOMERVILLE, 'Some Books Worth Reading'

3.45 Miss RHODA POWER: 'Village Life in Olden Times: 700 Years Ago'

IN these Talks, of which she is giving a series of six, Miss Rhoda Power (who has collaborated with her sister, Miss Eileen Power, in several of her recent books) will give a picture of the village in days when it was the primary unit of society and a real centre of every form of political, legal and social life.

4.0 Time Signal, Greenwich, THE DAVENTRY QUARTET and MAHOMMED ALI KHAN (Tenor), MAIRE WILSON (Violin)

5.15 THE CHILDREN'S HOUR: Piano Solos by GORDON BRYAN, 'Valentine Orson,' told by HARCOURT WILLIAMS, 'Billy' (H. Mortimer Batten)

6.0 ORGAN RECITAL by REGINALD FOORT, relayed from the New Gallery Cinema

6.20 The Week's Work in the Garden by the Royal Horticultural Society

6.30 WEATHER FORECAST, FIRST GENERAL NEWS BULLETIN

6.45 ORGAN RECITAL by REGINALD FOORT (Continued)

7.0 Ministry of Agriculture Talk by Sir FRANCIS FLOUDD, Secretary to the Ministry of Agriculture, 'Sugar Beet'

THE sugar beet industry is one that can suitably be carried on in this country, and of recent years strenuous efforts have been made to establish it. With the aid of the Ministry of Agriculture, factories have now been set up, and there seems a good prospect that a permanent addition may be made to the short list of our rural industries. In this talk Sir Francis Floudd, who is Permanent Secretary to the Ministry of Agriculture, will explain what has been done and what it remains to do.

7.15 THE FOUNDATIONS OF MUSIC  
Bach's 48 Preludes and Fugues  
Played through consecutively at this hour daily throughout the month

7.25 Prof. V. H. MOTTRAM, 'Present-Day Problems of Food: Modern Food Difficulties'

PEOPLE have only just begun to consider food from the scientific angle, and consult the chemists and physiologists as to what they should eat. Professor Mottram, who holds the Chair of Physiology in the University of London, was one of the first of the scientists to bring the laboratory into the kitchen, and his book, 'Food and the Family,' is a landmark in the history of popular dietetics. In this series of six Talks he will explain the importance of careful selection in feeding from the point of view of physical and mental efficiency and health.

7.45 THE CASANO OCTET  
Waltz, 'The Merry Peasant' ..... Fall  
Arabesque No. 1 ..... Debussy

HAROLD WILLIAMS (Baritone)  
Songs of Nyassaland ..... Theodore Holland  
THE OCTET

Selection, 'Madame Butterfly' ..... Puccini  
Arabesque No. 2 ..... Debussy

HAROLD WILLIAMS  
My Love's an Arbutus ..... Stanford  
Linden Lea ..... R. Vaughan Williams

THE OCTET  
She Dances ..... } Grieg  
Berceuse ..... }

THE melodies of the *Songs of Nyassaland*, collected by Mrs. Ella Kidney, are those used by various African native tribes in their ceremonies and rejoicings. Some of the songs come from near Lake Nyassa, while others are boat songs and travelling songs from near the Zambezi River, and they were all heard and noted in circumstances of actual native use. With one or two exceptions the English words which Mrs. Kidney has written are close translations of the original native words. Mr. Theodore Holland has arranged five of the melodies from the original collection for general use. They are free arrangements, but the melodies are unaltered.



Miss RHODA POWER, who gives the second talk in her series on Village Life in England in the Middle Ages, this afternoon at 3.45 from London.

1. *Travel*. A Road Song, suggesting endless weary walking along a hot road, the travellers' encouragement of each other by means of their songs, and the successful hunt for game by the way.

2. *Lamentation*. The Song of Mourning, used by some native tribes to the west of Lake Nyassa. The *Lament* is sung as a recitative, with the villagers joining in the refrain, 'hoya hoyo ho.'

3. *The Jolly Robbers*. This is a light-hearted song of harvest time.

4. *Boat Song*. This was heard on a little river flowing north from the Zambezi, within a short distance of the spot where, by the river bank, Mrs. David Livingstone was buried.

5. *A Chicken's Grief*. Another gay harvest song.

6. *Slavery*. This song originated among natives who had been captured and driven from their homes by slave raiders.

8.45 THROUGH ANOTHER'S EYES

Played by ADOLPHE HALIMS

ITALY (as seen by a Frenchman and an Englishman)  
Les Collines d'Anacapri (The Hills of Anacapri)  
Debussy

Mediterranean ..... Arnold Bax

ENGLAND (as seen by a Frenchman)  
Homage to S. Pickwick, Esq., P.P.M.P.C.  
Debussy

BRAZIL (as seen by a Frenchman)  
Sumara (from Brazilian Dances) ..... Milhaud

DEBUSSY'S picture of the hills of Anacapri, near Naples, glows with the light and warmth of the Italian sun. We hear suggestions of the gay Tarantella dance and of a popular love-ditty.

BAX, in *Mediterranean*, sets up a gracefully languorous theme that transports us at once to a Southern seaboard. To this theme succeeds a playful, liting melody, and these contrasted moods prevail throughout.

IN his *Pickwick* piece, Debussy seems to be poking good-humoured fun at the great man's qualities of gravity and playfulness. By the introduction of a few bars of our National Anthem he perhaps suggests that Mr. Pickwick stands for the British nation.

SOME of Milhaud's music has already been broadcast. This young Frenchman (he is thirty-five) formed one of the little band until recently known as 'The Six.' Actually, they had not very much in common, except, perhaps, a general spirit of revolt against the supposed mistiness and subtlety of Debussy and his followers.

9.0 WEATHER FORECAST, SECOND GENERAL NEWS BULLETIN; Local Announcements

9.15 Topical Talk

9.30-11.0 MY PROGRAMME  
by J. C. SQUIRE

TWO-NIGHT listeners will hear a programme arranged and introduced by a distinguished man of letters. Mr. J. C. Squire is editor of the *London Mercury*, a literary review that has published the work of almost every living British writer of eminence; his own criticisms in the *Observer* carry as much weight as any of the week; and his books include volumes of poetry that have assured him an acknowledged place amongst contemporary poets.

It will be found that Mr. Squire has chosen a programme illustrative of the history of British Songs from mediæval times up to the early days of the last century, beginning with the thirteenth-century 'Sumer is I-cumen in' (a reproduction of the original MS. of which will be found on the next page). To-night's programme will trace the development of our songs up to the time of Tom Moore and the first Victorian song writers, showing that tunefulness and gay spirits have always been the characteristics of British music. The sequence of the songs will be interspersed with orchestral music.

5XX DAVENTRY. 1,600 M.

10.30 a.m. TIME SIGNAL, WEATHER FORECAST

11.0 THE DAVENTRY QUARTET, with Viola, and NANCY HEPTON (Soprano); LEONARD F. PEARSON (Baritone); HAROLD FAIRHURST (Violin); GRACE PHILLIPS SANE WYNDHAM (Pianoforte)

1.0-2.0 S.B. from London

3.0 S.B. from London

7.45 THE KNELLER HALL BAND  
Director of Music, Lieut. H. E. ADKINS

Overture, 'Tam O'Shanter' ..... Drysdale

CHARLES TRUE (Baritone)  
The Ginchi Road ..... Lauri Edwards  
To the Forest ..... Tchaikovsky

THE BAND  
Male Voice Choir:

When Johnny Comes Down to Hilo... German  
Simple Simon ..... Hughes

Episode, 'Carnival in Paris' ..... Scendzen

CHARLES TRUE  
So We'll Go No More A-roving .... M. V. White  
Sons of the Sea ..... Coleridge-Taylor

THE BAND  
Fourth Movement from 'The New World  
Symphony' ..... Dvorak

8.45 S.B. from London

9.10 Shipping Forecast

9.15 S.B. from London

11.0-12.0 DANCE MUSIC: THE LONDON RADIO DANCE BAND from the Olympia Dance Hall

# PROGRAMMES FOR WEDNESDAY (January 19)

## 5IT BIRMINGHAM. 491.3 M.

3.45 London Programme relayed from Daventry

4.0 THE STATION WIND QUINTET

4.45 AFTERNOON TOPICS: HELEN M. ENOCH, 'The Romance of the Lighthouse.' ETHEL WILLIAMS (Contralto)

5.15 THE CHILDREN'S HOUR

6.0 LOZELLS PICTURE HOUSE ORCHESTRA, conducted by PAUL RIMMER

Overture, 'Marinerella', Fucik  
Selection from 'The Maid of the Mountains', Fraser-Simson  
March, 'The Prince's Return', Reynders

6.20 S.B. from London

7.45 PART SONGS

THE STATION REPERTORY CHORUS, conducted by JOSEPH LEWIS

O, Who Will O'er the Downs, Pearsall  
Sweet and Low, Barnby  
When Evening's Twilight, Hutton  
Sleep, Gentle Lady, Bishop

8.0 'MARY STUART'

(The Queen of Love and Sorrow)  
Written by IDA M. DOWNING  
Played by THE STATION PLAYERS

Characters:  
Mary Stuart, IDA M. DOWNING  
Mary Hamilton

PHYLLIS RICHARDSON  
Mary Beaton

GLADYS COLBOURNE  
Rizzio, an Italian, slightly deformed, devoted to the Queen...

PERCY EDGAR  
Darnley, Mary's Young Husband  
Bothwell, Mary's Lover, afterwards her Husband

JOSEPH LEWIS

AN ante-room in Holyrood Palace, Edinburgh; soft music is heard from below; Rizzio is playing and singing to the Queen, who is still in her bed-chamber. The two maids of honour are arranging the room and talking; Mary Beaton hums as she crosses to the window and opens it.

8.30 CHORUS

Laugh at Loving if, You Will, Percy Pitt  
A Love Symphony

Three Doughty Men, Pearson  
Breathe Soft, Ye Winds, Paton

8.45 S.B. from London (9.10 Local News)

9.30-11.0 LIGHT SYMPHONY

THE STATION ORCHESTRA, conducted by JOSEPH LEWIS

Overture to 'The Marksman' ('Der Freischütz'), Weber  
DALE SMITH (Baritone) and ORCHESTRA

Aria, Madamina ('Don Giovanni'), Mozart  
My Heart is Merry ('Phoebus and Pan'), Bach

ORCHESTRA

Slow Movement and Finale from the 'Surprise' Symphony, Haydn

THE Symphony gets its name from one chord in the SLOW MOVEMENT. This Movement, a gently but steadily progressing Air with Variations, begins very softly on Strings alone. Then, at the sixteenth bar, comes a crash from the whole Orchestra—the 'surprise'

The LAST MOVEMENT is a quick, jolly one. Note the many instances of Haydn's playful use of alternating Wind and String passages.

ALICE COUCHMAN (Pianoforte)

Valse in F, Op. 34, No. 3, Chopin  
Prelude in B Flat, Paganini, arr. Liszt  
Study No. 6, Paganini, arr. Liszt

ORCHESTRA

Ballet Music to 'Hérodias', Massenet  
DALE SMITH

Gifts of Gold and Amber, Cleghorn-Thomson  
Heraclitus, Cleghorn-Thomson

## 6BM BOURNEMOUTH. 326.1 M.

3.0 London programme relayed from Daventry

4.0 THE STATION OCTET

Selection, 'La Gioconda', Ponchielli

4.15 TOM BROWN (Baritone)

A Song of Thanksgiving, F. Allisen  
The Little Shawl of Blue, T. J. Hewitt

4.25 OCTET

Two Entr'actes:  
Tinkerbelle, Ramsey  
The Midge, Julian Clifford

4.35 TOM BROWN

Song Cycle, 'Songs of Syria', (Eusthace Martin), Mountain Rose of Lebanon; The Garden of Urmia; The Crimson Rose; Osarna Mine

4.45 OCTET

A Pagoda of Flowers, Woodforde-Finden

5.0 TOM BROWN

Four Jolly Sailors, German

5.5 OCTET

Tango, Albainz  
Love's Dream After the Ball, Czibulka

5.15 THE CHILDREN'S HOUR

6.0 ORCHESTRAL MUSIC relayed from the Grand Super Cinema, Westbourne, Bournemouth, Directed by ISADORE GODOWSKY

6.20 S.B. from London

7.45 THE STATION OCTET

Two Irish Dances, John Ansell

7.50 LOUIS HERTZEL, the 'Almost Silent,' in 'Mrs. Struggles'

7.58 OCTET

Two Parisian Sketches, P. Fletcher

8.3 PATRICIA ROSSBOROUGH (Entertainer)

I'd Climb the Highest Mountain, Brown and Clavin  
I Wouldn't Be One Bit Surprised, Donaldson

8.11 OCTET

Fox-trot, 'Soudan', Sebek

8.16 LOUIS HERTZEL, the 'Almost Silent,' in 'Radio Echoes'

8.24 OCTET

Valse, 'Zelma', Haines

8.29 PATRICIA ROSSBOROUGH

After I Say I'm Sorry, Donaldson  
I Want to Know, P. Rossborough  
Waiting for the Moon, S. Lerner

8.37 OCTET

I Love You Truly, Jacobs-Bond

8.45 S.B. from London (9.16 Local News)

9.30 A SHAKESPEARE PROGRAMME

The Scenes presented by THE STATION PLAYERS: LILIAN EDWARDS, JOYCE PAGE, JEAN BULLEN, MARGARET HITCHENS, GEORGE MORLEY, A. S. MARKWELL, GEORGE STONE and THE GREEN-LEAF PLAYERS:

JOAN RAYNER and BETTY RAYNER  
The Songs by Miss WINIFRED ASCOTT (Soprano)  
The Music by THE STATION OCTET, directed by REGINALD S. MOUNT

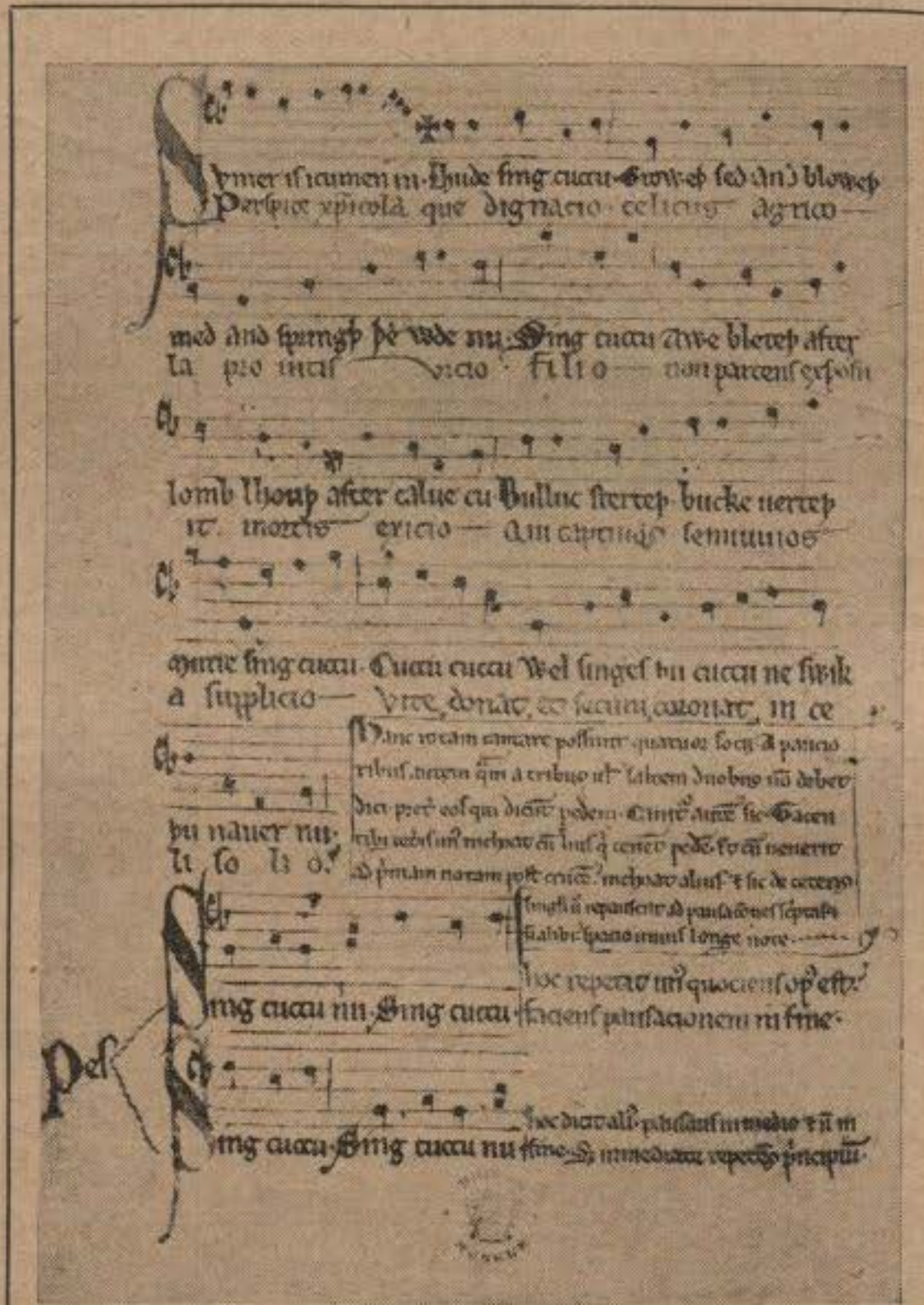

By courtesy of the British Museum

The manuscript (A.D. 1240) of the thirteenth-century song, 'Sumer is i-cumen in,' to initiate Mr. J. C. Squire's programme of British Songs, which will be broadcast from London at 9.30 to-night. This is the earliest specimen of harmonized secular music in existence. Alternative sacred words (in Latin) are also given in the MS., which was the work of John of Fornsote, a monk of Reading Abbey, who may also have composed the tune. The original M.S. is in the British Museum.

The Yellow Boreen, arr. Somervell  
Lassie wi' the Yellow Coatie, arr. Robert Macleod  
ORCHESTRA

First Suite from 'Carmen', Bizet

The Pianos in use in the various stations of the British Broadcasting Corporation are by CHAPPELL and WEBER.

# PROGRAMMES FOR WEDNESDAY (January 19)

**9.30 'THE MERCHANT OF VENICE'**  
 Prelude to the Incidental Music ..... *F. Rosse*  
 The Casket Scene (Act III., Sc. 2)  
 The Song, 'Tell Me Where is Fancy Bred'  
 (Sung by WINIFRED ASCOTT)

**9.45 'AS YOU LIKE IT'**  
 Songs { 'Under the Greenwood Tree' .... *Parry*  
 'Blow, Blow, Thou Winter Wind' *Quilter*  
 (Sung by WINIFRED ASCOTT)  
 'Rosalind and Orlando in the Forest of Arden'  
 (Act IV., Sc. 2)  
 These Scenes presented by THE STATION PLAYERS

**10.0 'THE TWO GENTLEMEN OF VERONA'**  
 Scenes presented by THE GREENLEAF PLAYERS  
 Produced by CONSTANCE SMEDLEY

Act I., Scene 2 { Julia, beloved of Proteus  
 BETTY RAYNER  
 Act II., Scene 7 { Lucette, her waiting-woman  
 JOAN RAYNER  
 Act IV., Scene 4 { Julia, disguised as Sebastian  
 BETTY RAYNER  
 Silvia, beloved of Valentine  
 JOAN RAYNER

With incidental music by LULLY, FRESCOBALDI  
 and others. Music to the Madrigal, 'Who  
 is Sylvia?' composed by *Maxwell Armfield*

**10.30 'A MIDSUMMER NIGHT'S DREAM'**  
 The Scherzo from MENDELSSOHN'S Music  
 'The Quarrel between Oberon and Titania'  
 (Act II., Sc. 1)  
 Song, 'I Know a Bank' ..... *Martin Shaw*  
 (Sung by WINIFRED ASCOTT)

**10.45-11.0 'TWELFTH NIGHT'**  
 Song, 'O Mistress Mine! Where Are You Roam-  
 ing?' ..... *Benjamin Dale*  
 (Sung by WINIFRED ASCOTT)  
 'The Gulling of Malvolio'  
 (Act II., Sc. 5)  
 These Scenes presented by THE STATION PLAYERS  
 Overture to 'The Merry Wives of Windsor'  
*Nicolai*

---

**5WA CARDIFF. 353 M.**

**3.0-3.45** London Programme relayed from  
 Daventry

**4.15** THE DANSANT: MUSIC by THE LONDON  
 CHORDEANS, relayed from Cox's Café

**4.45** Miss MARY ROSE, 'Beautifying the Home:  
 Renovating the Household Gods'

**5.0** THE DANSANT (Continued)

**5.15** THE CHILDREN'S HOUR

**6.0** Mr. B. PERROTT, 'Our Neighbours in Space  
 —The Sun'

**6.15** Local Radio Society's Bulletin

**6.20** S.B. from London

**7.45 MUSIC AND COMEDY**  
 THE STATION ORCHESTRA, conducted by WARWICK  
 BRAITHWAITE  
 Prelude and Clair de Lune (Werther) .. *Massenet*

**7.50** GLANVILLE DAVIES (Baritone)  
 John of Devon ..... *Sylvia Mortlake*  
 A Bachelor Gay (The Maid of the Mountains)  
*Tato*

**7.55** ORCHESTRA  
 Danse Russe ..... *Tchaikovsky*

**8.0 'A SHARP ATTACK'**  
 By HERBERT C. SARGENT  
 Played by THE LONDON RADIO REPERTORY  
 PLAYERS  
 Characters:  
 Ezekiel Meggs (a Grocer and General Dealer)  
 J. HUBERT LESLIE  
 William Kitson (a Mate on a Tramp Steamer)  
 HENRY OSCAR  
 Minnie Brown (a Nurse) .... PHYLLIS PANTING

IN Ezekiel Meggs' sitting-room, a bare, cheer-  
 less apartment giving an impression of  
 extreme poverty, a very small fire is burning.  
 At the back of the room, which is lighted by one  
 candle, there is a glazed partition through which  
 his shop can be seen. Meggs, a small, wizened  
 man of about forty, is sitting at the table casting  
 up figures in a ledger.

**8.26** ORCHESTRA  
 Shepherd and Shepherdess (Bal Costumé, No. 3)  
*Rubinstein*

**8.30** GLANVILLE DAVIES (Baritone)  
 The Widow of Penzance ..... *Eric Coates*  
 A Devonshire Wedding ..... *Lyall Phillips*

**8.35** ORCHESTRA  
 Overture to 'Ruy Blas' ..... *Mendelssohn*

**8.45** S.B. from London (9.10 Local News)



Mesdames Edith Jervis and Alice Lakin  
 will take part in this evening's concert from the  
 Plymouth Studio [7.45].

**9.30 TIDES**  
 'Now is the season for a ship to run through  
 the gurgling water,  
 Therefore wind up your soaked cables, O sailors,  
 and weigh  
 Your hidden anchors from the harbours, and  
 stretch the forestays to carry your well-  
 woven sails.'—*Antipater of Sidon*

THE STATION ORCHESTRA, conducted by WAR-  
 WICK BRAITHWAITE

A Nautical Overture, 'Britannia' .. *Mackenzie*

**9.38** THE LYRIAN SINGERS  
 Haul Away, Joe ..... *arr. Terry*

**9.4** JOHN HENRY  
 A Breezy Interlude

**9.54** ORCHESTRA  
 Imploration to Neptune (Phèdre) .. *Massenet*

**10.0** SYBIL MADEN (Contralto)  
 Three Fishers Went Sailing ..... *Hullah*

**10.4** ORCHESTRA  
 The Deluge ..... *Saint-Saëns*

**10.12** SYBIL MADEN  
 Sabbath Morning at Sea (Sea Pictures) .. *Elgar*

**10.16** ORCHESTRA  
 Overture, 'Plymouth Hoe' ..... *Ansell*

**10.22** THE LYRIAN SINGERS  
 What Shall We Do With the Drunken Sailor?  
*arr. Terry*

**10.28** JOHN HENRY  
 gets the 'Breeze Up'

**10.38** ORCHESTRA  
 Forecastle Frolics (Nautical Scenes) .. *Fletcher*

**10.41** SYBIL MADEN  
 Have You News of My Son Jack? .... *Homer*

**10.44** THE LYRIAN SINGERS  
 Hanging Johnny ..... *arr. Terry*

**10.50-11.0** ORCHESTRA  
 Excerpts from 'A Life on the Ocean' .. *Binding*

**2ZY MANCHESTER. 384.6 M.**

**3.0** London Programme relayed from Daventry

**4.0** TEA-TIME CONCERT: ORCHESTRAL MUSIC from  
 the Piccadilly Theatre

**5.0** EVELYN BANBERY (Mezzo-Soprano)

**5.15** THE CHILDREN'S HOUR: 'Seen from the  
 Magic Casement'—(2)

**6.0** Light Music by THE STATION QUARTET  
 March, 'El Capitan' ..... *Sousa*  
 Serenata ..... *Toselli*  
 Evensong ..... *Easthope Martin*  
 Selection from 'La Traviata' .. *Verdi, arr. Tavan*

**6.20** Royal Horticultural Society's Bulletin

**6.30** S.B. from London

**7.45 MUSIC AND PLAYS**  
 THE STATION QUARTET  
 Selection, 'The Passing Show' ..... *Finch*  
 'PLAYING WITH FIRE'  
 An event in Little Hogsmyrtle in Two Acts  
 by J. P. M. LOCKWOOD and G. R. ESTILL  
 Cast:  
 Councillor William Blower .. E. H. BRIDGSTOCK  
 Councillor Higson ..... CHARLES NESBITT  
 Councillor Joshua Serimp ..... W. E. DICKMAN  
 Councillor Mark Stillwater .... LEO CHANNING  
 Martha Jolly ..... MARY EASTWOOD  
 Miss Rebecca Wibble ..... LUCIA ROGERS

SCENE 1 is laid in the garden of the Bull  
 Inn, and we hear a discussion between  
 William Blower, a prosperous farmer and local  
 'know-all,' and Joshua Serimp, who combines  
 the duties of market gardener and insurance  
 agent in the village.  
 In Scene 2 we are introduced to the Council  
 Chamber, where a heated discussion is in pro-  
 gress regarding the fire-engine.  
 Musical Interlude by THE QUARTET  
 Pas des Fleurs ..... *Delibes*  
 'THE REST HOUSE'  
 A Satire in One Act by ANDREW HARDING  
 Cast:  
 Professor Brottleybury .... E. H. BRIDGSTOCK  
 Henry Dale ..... W. E. DICKMAN  
 Mary Dale ..... HYLDA DICKMAN  
 Keeper of the Rest House E. H. BRIDGSTOCK  
 The scene is laid in the drawing-room of Henry  
 Dale's house, the strains of Dance Music may be  
 heard from next door.  
 Performed by the STATION REPERTORY PLAYERS

**8.45** S.B. from London (9.10 Local News)

**9.30-11.0 POPULAR REQUEST CONCERT**  
 THE STATION ORCHESTRA, conducted by T. H.  
 MORRISON  
 Overture, 'Poet and Peasant' ..... *Suppé*  
 Chang (A Mandarin Dance) ..... *Finch*  
 SOPHIE ROWLANDS (Soprano)  
 Ave Maria ..... *Bach-Gounod*  
 Ecstasy ..... *Rummel*  
 STRING ORCHESTRA  
 Fairy Dream ..... *Blon*  
 TOM KINNIBURGH (Bass)  
 Myself When Young ..... *Liza Lehmann*  
 Vulcan's Song ..... *Gounod*  
 ORCHESTRA  
 A Lightning Switch ..... *Alford*  
 SOPHIE ROWLANDS  
 Air de Lia (from L'Enfant Prodigue) .. *Debussy*  
 Le Tasse ('Les Regrets') ..... *Godard*  
 TOM KINNIBURGH  
 Jenny's Way ..... *Willeby*  
 Royster Doyster ..... *Matheson*  
 ORCHESTRA  
 Selection from the Works of Tchaikovsky  
*arr. Langey*

# PROGRAMMES FOR WEDNESDAY (January 19)

**6KH HULL. 288.5 M.**

- 3.30 Light Music
- 3.45 London Programme relayed from Daventry
- 4.0 Light Music
- 4.15 FIELD'S QUARTET, relayed from the New Restaurant, King Edward Street
- 5.15 THE CHILDREN'S HOUR
- 6.0 London Programme relayed from Daventry
- 6.20 Royal Horticultural Society's Bulletin
- 6.30 S.B. from London
- 7.45 **MEDLEY**  
THE HULL GLEEMEN  
He That Hath a Pleasant Face ..... *Hutton*  
Go Rose .....  
The Evening Walk ..... *Belle*
- 7.55 BERT COPLEY (Humorist-Entertainer) in 'Laughs and Logic'
- 8.5 NINA FRONORA (Contralto)  
What's In the Air To-day? ..... *Robert Eden*  
What a Wonderful World It Would Be .. *Löhr*  
La Vie est Vaine (Song of Life) .... *Del Riego*
- 8.15 GLEEMEN  
How Beautiful is Night ..... *Kearton*  
To Celia ..... *Lee Williams*  
Hey Nanny No ..... *Armstrong Gibbs*  
The Long Day Closes ..... *Sullivan*
- 8.25 BERT COPLEY—in 'More Laughs and Logic'
- 8.35 NINA FRONORA  
Home Isn't Home Without You ..... *Löhr*  
Come Close To Me ..... *Gerald Carne*  
The Love Song of the Her Dyall ..... *Batten*

- 8.45 JOHN H. SIGALL ('Cellist')  
Ave Maria ..... *Schubert-Lindner*  
Liebeslied ..... *Kreisler*  
Pavane Pour une Infante Defunte ..... *Ravel*  
Arlequin ..... *Popper*
- 9.0-11.0 S.B. from London (9.10 Local News)

**2LS LEEDS-BRADFORD. 277.8 M. & 254.2 M.**

- 11.30-12.30 FIELD'S CAFÉ ORCHESTRA, relayed from Field's Café, Leeds
- 4.0 THE LEEDS-BRADFORD LIGHT SYMPHONY ORCHESTRA, relayed from Fenton Street Drill Hall, Leeds, on the occasion of the Yorkshire Post Building Trades Exhibition
- 5.0 AFTERNOON TOPICS: Miss DORIS NICHOLS, 'Songs by Edward German'
- 5.15 THE CHILDREN'S HOUR
- 6.0 Light Music
- 6.20 Royal Horticultural Society's Bulletin
- 6.30-11.0 S.B. from London (9.10 Local News)

**6LV LIVERPOOL. 297 M.**

- 3.0 CRANE'S MATINEE CONCERT, relayed from Crane Hall  
HETTY BOLTON (Pianoforte); LEVA LEACH (Contralto); CLYDE TWELVETREES ('Cello) and WALTER WRIGHT (Accompanist)
- 3.45 London Programme relayed from Daventry
- 4.0 MONTAGUE'S SYMPHONICS, relayed from the Edinburgh Café Ballroom
- 5.0 AFTERNOON TOPICS: W. A. MARTIN, 'Humours and Tragedies of Trekking in the Gold Coast' (Part II.)

**5.15 THE CHILDREN'S HOUR**

- 6.0 MONTAGUE'S SYMPHONICS, relayed from the Edinburgh Café Ballroom
- 6.20 S.B. from Manchester
- 6.30-11.0 S.B. from London (9.10 Local News)

**5NG NOTTINGHAM. 275.2 M.**

- 11.30-12.30 Morning Concert, relayed from Daventry
- 3.45 London Programme relayed from Daventry
- 4.0 THE MIKADO CAFÉ ORCHESTRA, conducted by FREDERICK BOTTOMLEY
- 4.45 Music and Afternoon Topics
- 5.15 THE CHILDREN'S HOUR
- 6.10 A READER: 'New Books'
- 6.20 S.B. from London
- 7.45 CLIFTON COLLIERY PRIZE BAND  
Selection from L'Arlesienne ..... *Bizet*  
ANGUS MICHE (Baritone)  
Trade Winds ..... *Keel*  
Down Among the Dead Men ..... *Traditional*  
Up From Somerset ..... *Sanderson*  
BAND  
Suite, 'A Rustic Holiday' ..... *W. Rimner*  
ANGUS MICHE  
Why Shouldn't I? ..... *Kennedy Russell*  
The Song of the Waggoner ..... *Breville Smith*  
The Devil's Awa' wi' the Excoisemen' .... *Scotch*  
BAND  
Fantasia, 'A Military Church-Parade' .. *Hume*
- 8.45-11.0 S.B. from London (9.10 Local News)

## EDISON BELL RADIO

"THE CONNOISSEUR'S FIRST CHOICE"

### CHARM!

charm is expressed both in the tone and design of the

### NEW MODEL EDISON BELL SPEAKER

the artistic appearance of which is second only to its pure tonal reproduction.

**PRICE 42/-**

(Of all "Live" Dealers.)

**NO METAL HORN—NO METAL DIAPHRAGM—NO METALLIC NOISE.**

Ask your dealer for new Illustrated Catalogue, if unable to obtain, write direct:—



TESTED 500 VOLTS  
500 TYP.

EDISON BELL, LIMITED,  
LONDON, S.E.15, AND AT HUNTINGDON.



TESTED 500 VOLTS  
500 TYP.

**INSIST ON EDISON BELL CONDENSERS**

THEY ARE BRITISH MADE AND GUARANTEED BY A NAME WITH 30 YEARS REPUTATION BEHIND IT

## NOTICE.

*Patents in connection with Broadcast Receivers.*

MARCONI'S WIRELESS TELEGRAPH COMPANY LIMITED of Marconi House, Strand, London, W.C.2, have knowledge of many cases in which unauthorised use is made of their patents by the construction, use or disposal of unlicensed broadcast receivers.

The bona fide experimenter will have, as hitherto, the free use of patents owned by the Company, but all who desire to be secure in this privilege must submit their names to the Company with a statement of the grounds upon which their claim is based. In approved cases a free personal license will then be issued.

SUBJECT to this single exception no person who assembles a broadcast receiver from components (whether made by himself or others, or partly by himself and partly by others), either for his own use or for disposal by way of sale, exchange or gift, is entitled to use the patents owned by the Company except upon payment of the appropriate royalty. Upon payment of the royalty a specially numbered plate will be supplied by the Company to be affixed to the receiver. In cases of doubt whether or not a particular apparatus employs any of the patents owned by the Company, enquiry should be made of the Company.

ANY person making use or disposing of an unlicensed receiver employing any of the patents owned by the Company is liable to legal proceedings for infringement.

THE public will doubtless appreciate that the Company's attitude is the only one compatible with the efficient protection of the legitimate licensed manufacturer, who has to pay heavy overhead charges, in addition to the usual royalties. The Company wish, therefore, to give this special notice of their intention to take such action as may be necessary to protect their patent rights and those of their licensees.

THIS notice cancels all previous notices issued by the Company as to the use of patents in connection with Broadcast Receiving Apparatus.

# PROGRAMMES FOR WEDNESDAY (January 19)

## 5PY PLYMOUTH. 400 M.

- 11.0-12.0 GEORGE EAST and his QUARTET, relayed from Popham's Restaurant
- 3.30 Gramophone Recital
- 3.45 London Programme relayed from Daventry
- 4.0 AFTERNOON TOPICS: Mr. C. W. BRACKEN, 'Oak and Other Galls'
- 4.15 TEA-TIME MUSIC: THE ROYAL HOTEL TRIO, directed by ALBERT FULLBROOK
- 5.15 THE CHILDREN'S HOUR
- 6.0 STANLEY VESEY (Baritone)
- 6.20 S.B. from London
- 7.45 THE STATION ORCHESTRA, directed by WINIFRED GRANT  
Entrée des Tziganes (Ballet Suite, 'Les Deux Pigeons') ..... *Messenger*  
Madame ALICE LAKIN (Contralto)  
Just (By Request) ..... *John Bradford*  
Believe Me If All Those Endearing Young Charms (By Request) ..... *Irish Folk Song*  
Happy Song ..... *Del Biego*  
EDITH JERVIS (Solo Violin)  
Sarebade ..... *Ries*  
Adegio and Allegro ..... *Handel*
- 8.5 FLORENCE OLDBAM and TOMMY HANDLEY
- 8.25 EDITH JERVIS  
Meditation ..... *Bach-Gounod*  
Berceuse ..... *Gabriel Fauré*  
Madame ALICE LAKIN  
Hope (The Time of Roses) ..... *Old German Air*  
Verdi Prato (Alicina) ..... *Handel*  
A May Morning ..... *Danza*  
ORCHESTRA  
Scène from the Ballet Suite, 'The Two Pigeons' ..... *Messenger*
- 8.45-11.0 S.B. from London (9.10 Local News)

## 6FL SHEFFIELD. 272.7 M.

- 11.30-12.30 Gramophone Records
- 3.45 London Programme relayed from Daventry
- 4.0 AFTERNOON TOPICS: KATE BALDWIN, 'Soups for Cold Days'
- 4.15 London Programme relayed from Daventry
- 5.15 THE CHILDREN'S HOUR
- 6.0 Musical Interlude
- 6.20 Horticultural Bulletin
- 6.30 S.B. from London
- 7.45 SHEFFIELD UNIVERSITY EVENING  
A programme arranged by Mr. G. E. LINFOOT, Mus.Bac., Lecturer in Music in the University, on the occasion of the presentation of a microphone to the University by Mr. F. LLOYD
- 8.45 S.B. from London (9.10 Local News)
- 9.30 THE DONCASTER 'BRECKIN' CHOIR, conducted by ARNOLD WILLIAMS  
In a Programme of Unaccompanied Choral Numbers  
Jerusalem ..... *Parry*  
Now Shall the Grace ..... *Bach*
- 9.42 HILDA FRANCIS (Piano)  
Intermezzo, No. 1 ..... *Brahms*  
Scherzo in B Flat Minor ..... *Rosenbloom*
- 9.52 CHOIR  
Now Let Her Change and Spare Not ..... *Francis Pilkington*  
In These Delightful Pleasant Groves .. *Purcell*  
Come, Let Us Join the Roundelay .. *Wm. Beale*

- 10.2 HILDA FRANCIS  
Grand Concert Valse ..... *Glazounov*
- 10.10 CHOIR  
Full Fathom Five ..... *Chas. Wood*  
The Splendour Falls ..... *F. Delius*
- 10.19 HILDA FRANCIS  
Allegro Appassionato ..... *Saint-Saëns*  
Toccata (Third Suite) ..... *York Bowen*
- 10.30 CHOIR  
Six Nursery Rhymes ..... *Adam Carse*  
An Eriskay Love Lilt ..... *arr. Hugh S. Robertson*  
CHOIR  
Laugh and Be Merry ..... *Arnold Williams*
- 10.43 HILDA FRANCIS  
Etudes Symphoniques, No. 12 (Finsle) *Schumann*
- 10.48-11.0 CHOIR  
Jack and John ..... *Bantock*  
Dead in the Sierras ..... *Coleridge-Taylor*  
When Allan-a-Dale ..... *R. L. d. Pearsall*  
A Festival Hymn ..... *C. Lee Williams*

## 6ST STOKE. 288.5 M.

- 3.0 London Programme relayed from Daventry
- 5.0 AFTERNOON TOPICS: A. RIGBY, 'Uses of Clays'
- 5.15 THE CHILDREN'S HOUR
- 6.0 Light Music
- 6.20 S.B. from London (9.10 Local News)
- 9.30-11.0 EXCERPTS FROM  
'CARMEN' and 'RIGOLETTO'  
with ORCHESTRA  
Conducted by HAROLD MORRIS
- ORCHESTRA  
Carmen Prelude  
ETHEL POTTS (Contralto)  
Habanera  
CECIL COOPER (Baritone)  
Song of the Toreador  
ETHEL POTTS  
Seguidilla  
EDITH MAYLAND (Soprano)  
Air of Micaëla  
ETHEL POTTS and FRANK EDGE (Duet)  
At Last 'tis Thine  
FRANK EDGE (Tenor)  
Flower Song  
ORCHESTRA  
Prelude to 'Rigoletto'  
EDITH MAYLAND and CECIL COOPER  
Duet, 'Veglia O Donna' (O, Guard This Flower of Wondrous Beauty)  
FRANK EDGE  
Questa e Quella (This or That)  
La Donna e Mobile (Woman is Fickle)  
EDITH MAYLAND  
Caro Nome (Dear Name)  
EDITH MAYLAND and FRANK EDGE  
E il Sol dell' Anima (Love is the Sun)  
CECIL COOPER  
Cortigiana Vil Razza Dannata (Vile Race of Courtiers)  
EDITH MAYLAND, ETHEL POTTS, FRANK EDGE and CECIL COOPER  
Bella Figlia dell' Amore (Fairest Daughter of the Graces)
- 5SX SWANSEA. 288.5 M.
- 3.0 London Programme relayed from Daventry
- 4.0 THE CASTLE CINEMA ORCHESTRA and ORGAN Music, relayed from the Castle Cinema

- 4.30 Gramophone Records
- 5.0 Afternoon Topics
- 5.15 THE CHILDREN'S HOUR
- 6.0 THE STATION TRIO  
Little Ballet Suite, 'Vive la Danse' .... *Finck*  
Pas de Deux; Pas Seul; Ensemble Finale  
BESSIE GRIFFITHS-HOWELLS (Contralto)  
Bid Me to Love ..... *Barnard*  
Three Green Bonnets ..... *G. d'Hardelot*  
Over the Mountain ..... *Roger Quilter*
- 6.20 S.B. from London
- 7.45 TRIO  
Selection, 'A Masked Ball' ..... *Verdi-Alder*
- 8.0 'A SHARP ATTACK'  
By HERBERT C. SARGENT  
Played by the LONDON RADIO REPERTORY PLAYERS  
(For further particulars, see Cardiff Programme)
- 8.26 BESSIE GRIFFITHS-HOWELLS  
O Love, From Thy Power ..... *Saint-Saëns*  
Cweu Fach ..... *Traditional*  
TRIO  
In Arcady ..... *Lescant*  
Meditation in C ..... *W. H. Squire*
- 8.45-11.0 S.B. from London (9.10 Local News)

## Northern Programmes.

### 5NO NEWCASTLE. 312.5 M.

- 3.0:—London Programme relayed from Daventry. 3.20:—Mr. Thomas Carter, 'Popular Science.' 3.45:—London Programme relayed from Daventry. 4.0:—Music from Fenwick's Terrace Tea Rooms. 5.0:—Miss Norah Ball: 'Through a Woman's Eyes' (6). 5.15:—Children's Hour. 6.0:—Dorothy Sanderson (Soprano). 6.8:—Jack Cairns (Baritone). 6.15:—Dorothy Sanderson. 6.20:—Royal Horticultural Society's Bulletin. 6.30:—S.B. from London. 7.45:—Music: The Station Octet. 8.0:—Con Conrad (the American Composer) in Some of his Latest Successes. 8.15:—The Station Octet; Lillian Rowell (Contralto). 8.45:—S.B. from London. 9.30:—Humour. The Three Tykes. 10.15-11.0:—Dance Music. Percy Bush's Aeolian Band, relayed from the Oxford Galleries.

### 5SC GLASGOW. 405.4 M.

- 3.0:—Dance Music relayed from the Locarno. 3.20:—Broadcast to Schools: Mr. G. W. Tyrrell, 'Story of the Earth' (1). 3.32:—St. Albert le Grip: French, 'Notre Dame de Paris.' 3.45:—Musical Item to Schools. 3.55:—The Wireless Quartet and Robert Marshall (Baritone). 5.0:—Afternoon Topics: Dreda Boyd, 'A Tourist's Steps—In and Out of Paris.' 5.15:—Children's Hour. 5.58:—Weather Forecast for Farmers. 6.0:—Dance Music, relayed from the Locarno. 6.20:—Dudley V. Howells, Horticultural Bulletin. 6.30-11.0:—S.B. from London.

### 2BD ABERDEEN. 500 M.

- 3.45:—London Programme relayed from Daventry. 4.0:—Steadman's Symphony Orchestra, relayed from the Electric Theatre. 4.45:—Robert D. Henderson (Baritone). 5.0:—Afternoon Topics. 5.15:—Children's Hour. 6.0:—Music by the Station Orchestra. 6.30:—S.B. from London. 7.45:—Community Concert relayed from Wesleyan Hall, Inverness. Soloists: Madame Janet Burns (Soprano), Neil McLean (Tenor). 8.45-11.0:—S.B. from London.

### 2BE BELFAST. 306.1 M.

- 3.0:—London Programme relayed from Daventry. 4.0:—The Dansant: The Carlton Orchestra. 5.0:—Afternoon Topics: Miss Edith C. Murphy, 'The Stars in Their Courses.' 5.15:—Children's Hour. 6.0:—The Radio Quartet. 6.25:—S.B. from London. 7.45:—Spain. Introductory Talk on Spanish Music, by Prof. I. G. Llubera. 7.55:—The Station Symphony Orchestra: La Procession del Rocío (Turina). 8.5:—Lia Rosa (Mezzo-Soprano); Quena, and Vidalita (Alberto Williams); Jota, and Seguidilla (Manuel de Falla). 8.15:—Antonio Brosa (Violinist): First Movement of 'Concerto Espanol' for Violin and Orchestra (Juan Manuel). 8.25:—Orchestra: Spanish Dances (Granados). 8.38:—Lia Rosa: Tonada de la Nina Perdida, Pano Murciano, Asturiana, and El Vito (arranged by Joaquin Nin). 8.48:—Antonio Brosa: La Cancion del Lunar, and Alucinaciones (I. Turina); La Vida Breve (M. de Falla-Kreisler). 9.0:—Weather Forecast, News; Local News. 9.15:—S.B. from London. 9.30:—Spain (Continued). Orchestra: Recit du Pocheur and Pantomime ('El Amor Brujo') (De Falla); Aragonesa (Pieces Espagnoles). 9.52:—Claude de Ville (Pianoforte); Navarra (Albeniz); Evocation (Albeniz); El Puerto (Albeniz); Eritana (Albeniz). 10.5:—Orchestra: Dances from the Ballet, 'El Sombrero de Tres Picos' (The Three Cornered Hat) (De Falla); Danzas Fantastias (Turina). 10.30-11.0:—The Northern Madrigal Singers.

# PROGRAMMES FOR THURSDAY (January 20)

2LO	LONDON.	361.4 M.	5IT	BIRMINGHAM.	491.8 M.	5WA	CARDIFF.	353 M.
1.0-2.0	The Week's Concert of New Gramophone Records		3.45 app.	<b>OPENING CONCERT</b> of the <b>WORCESTERSHIRE ASSOCIATION</b> of <b>MUSICAL SOCIETIES</b> (including the <i>Claines Musical Club, Pershore Choral Society and Abbey Choir, and the Worcester Association Choir and Orchestra</i> ) Conducted by <b>STEPHEN MOORE</b> Guest Conductors— <b>DR. ADRIAN C. BOULT</b> and <b>JOSEPH LEWIS</b> Guest Conductor and Leader— <b>JOHN W. AUSTIN</b> . Relayed from the Public Hall, Worcester Remarks concerning the scheme will be made by <b>STUART WILSON, DR. BOULT</b> and <b>JOSEPH LEWIS</b>		12.30-1.30	Lunch-time Music from the Cariton Restaurant	
2.30	BROADCAST TO SCHOOLS: Mrs. H. A. L. FISHER, 'Before and After the Great War: A Hundred Years Ago'			Excerpts from 'Messiah' ..... <i>Handel</i> Overture Recit., 'Comfort Ye'; Air, 'Every Valley'; Chorus, 'And the Glory of the Lord'; Recit., 'All They That See Him'; Chorus, 'He Trusted in God'; Recit., 'Thy Rebuke'; Air, 'Behold and See'; Recit., 'He Was Cut Off'; Air, 'But Thou Didst Not Leave His Soul in Hell'; Chorus, 'Lift Up Your Heads'; Chorus, 'Hallelujah' <i>Soloist: STEUART WILSON. Conducted by JOSEPH LEWIS</i> 'For the Fallen' ..... <i>Elgar</i> Poem by <b>LAURENCE BINYON</b> <i>Soloist: STEUART WILSON</i> Jerusalem (And Did Those Feet in Ancient Time) ..... <i>Parry</i> <i>Conducted by STEPHEN MOORE.</i>		3.0	<b>AN ORCHESTRAL CONCERT</b> <b>THE STATION ORCHESTRA</b> , conducted by <b>WARWICK BRAITHWAITE</b> A Famous Overture—to 'The Marksman' ('Der Freischütz') ..... <i>Weber</i> Dreaming ('Träumerei') Arranged for Strings, Clarinet and Horn ..... <i>Schumann</i>	
3.0	EVENSONG relayed from WESTMINSTER ABBEY		5.0	AFTERNOON TOPICS: <b>PHYLLIS VIVIAN</b> , 'Andalusian Memories—Dances of Spain'		3.15	BROADCAST TO SCHOOLS: <b>MR. GLYN EASTMAN</b> : 'Song Throughout the Centuries—English Vocal Music, Part II.	
3.55	WORCESTER MUSICAL SOCIETY'S CONCERT. <i>S.B. from Birmingham</i>		5.15	THE CHILDREN'S HOUR		3.40	ORCHESTRA Prelude, 'Minstrels' ..... <i>Debussy</i> Suite, 'The Atonement of Pan' ..... <i>Hadley</i> <b>J. MALDWYN THOMAS</b> (Baritone) Young Tom O'Devon ..... <i>Kennedy Russell</i> The Yeomen of Surrey ..... <i>Wm. Maro</i> Yeoman's Wedding Song ..... <i>Prince Poniatowski</i>	
5.0	A. BONNET LAIRD, 'Up Hill and Down Dale'		6.0	HAROLD TURLEY'S ORCHESTRA, relayed from Prince's Café			ORCHESTRA Symphony, No. 31, in D Major (With the Horn-signal) ..... <i>Haydn</i> <b>J. MALDWYN THOMAS</b> At Grendon Fair ..... <i>Paul Marie</i> I'll Sing Thee Songs of Araby ..... <i>Fredrick Clay</i> Captain Mac ..... <i>W. Sanderson</i>	
5.15	THE CHILDREN'S HOUR: Songs with Choruses by <b>J. R. CASTLING</b> . 'The Legend of Lady Alisoun and The Golden Bird' (Geoffrey Vickers). 'The Zoo School,' by <b>L. G. M.</b> , of the <i>Daily Mail</i>		6.15	<i>S.B. from London</i>			ORCHESTRA Two Pieces, (a) Berceuse ..... <i>Iljinsky</i> (b) The Lady Picking Mulberries ..... <i>Kelley</i> Whirling Dervishes, from the 'Triakontameron' <i>Godowski, arr. Schmid</i>	
6.0	MUSIC by THE DAVENTRY QUARTET		6.45	For Girl Guides		4.45	<b>MR. RICHARD BARRON</b> : 'An Afternoon With Shakespeare'	
6.15	Market Prices for Farmers		7.0	<b>MR. C. BRADLEY</b> : 'Physical Exercise—Its Point and Purpose'		5.0	Pianoforte Recital	
6.20	THE DAVENTRY QUARTET (Continued)		7.15	<i>S.B. from London</i>		5.15	THE CHILDREN'S HOUR	
6.30	WEATHER FORECAST, FIRST GENERAL NEWS BULLETIN		7.45	<i>S.B. from Manchester</i>		6.0	THE STATION DIRECTOR: 'To-day and To-morrow,' including the Fortnight's News of the Station	
6.45	Girl Guides' Programme		8.0-12.0	<i>S.B. from London</i> (9.25 Local News)		6.15	<i>S.B. from London</i>	
7.0	<b>MR. A. G. LINNEY</b> : 'Curiosities of the Port of London'		6BM	<b>BOURNEMOUTH. 325.1 M.</b>		7.0	<b>ALDERMAN W. DEACON</b> , Mayor of Bridgewater, 'The Story of the Bath Brick'	
7.15	THE FOUNDATIONS OF MUSIC Bach's 48 Preludes and Fugues Played through consecutively at this hour daily throughout the month		11.15-12.15	MID-DAY MUSIC by <b>F. G. BACON'S ORCHESTRA</b> , relayed from <b>W. H. SMITH and SON'S</b> Restaurant, The Square		7.15	<i>S.B. from London</i>	
7.25	<b>SIR FREDERICK LUGARD</b> , 'Africa's Clearing House'		2.30	London Programme relayed from Daventry		7.45	<i>S.B. from Manchester</i>	
7.45	VOICE AND PERSONALITY—II. Special Test conducted by <b>PROFESSOR T. H. PEAR</b> (Professor of Psychology, Manchester University) ( <i>S.B. from Manchester</i> ) (See article on page 101)		4.0	Afternoon Topics		8.0-12.0	<i>S.B. from London</i> (9.25 Local News)	
8.0	SIXTH B.B.C. NATIONAL CONCERT (For Programme see page 121)		4.15	TEA-TIME MUSIC by <b>F. G. BACON'S ORCHESTRA</b>		2ZY	<b>MANCHESTER. 384.6 M.</b>	
9.15	From the Studio: WEATHER FORECAST, SECOND GENERAL NEWS BULLETIN; Local Announcements		5.15	THE CHILDREN'S HOUR		1.30-12.30	Music by THE STATION QUARTET	
10.10	<b>JAN and CORA GORDON</b> : Wandering in the Balkans		6.0	Musical Interlude		4.30	AFTERNOON TOPICS: <b>Mrs. GEORGIA PEARCE</b> , 'Music in England in Shakespeare's Day'	
10.30-12.0	DANCE MUSIC. THE SAVOY ORPHEANS and THE SYLVIANs from the Savoy Hotel		6.15	<i>S.B. from London</i>		4.45	TEA-TIME MUSIC: <b>J. MEADOWS</b> (Auto-Piano Recital)	
5XX	<b>DAVENTRY. 1,600 M.</b>		7.0	<b>MR. GEORGE DANCK</b> , 'Gardening'		5.0	<b>DORA DAY</b> (Soprano)	
10.30 a.m.	TIME SIGNAL, WEATHER FORECAST		7.15	<i>S.B. from London</i>		5.15	THE CHILDREN'S HOUR	
11.0	THE BARNARDO'S HOMES MUSICAL BOYS' BAND <b>EDWARD LANKOW</b> (Bass); <b>GUY MAGRATH</b> (Violin); <b>SIDNEY HARRISON</b> (Pianoforte)		7.45	<i>S.B. from Manchester</i>		6.0	ORGAN MUSIC relayed from the PICCADILLY PICTURE THEATRE ORGANIST: <b>JOHN ARMITAGE</b>	
11.45 app.	THE WESTMINSTER STRING QUARTET Quartet in G Major ..... <i>Haydn</i>		8.0	<i>S.B. from London</i> (9.25 Local News)		6.15	<i>S.B. from London</i>	
12.5 app.	CONCERT (Continued)		10.30	<b>CON CONRAD</b> (The American Composer) in Some of his Latest Successes		7.0	'The Woman Behind the Job'—(4) 'We Interview a General Service Agent'	
1.0-2.0	<i>S.B. from London</i>		10.45-12.0	<i>S.B. from London</i>		7.15	<i>S.B. from London</i>	
2.30	<i>S.B. from London</i>					7.45	VOICE AND PERSONALITY (II) Special Test conducted by <b>Prof. T. H. PEAR</b> (Professor of Psychology, Manchester University) (See Special Article on page 101)	
7.45	<i>S.B. from Manchester</i>					8.0-12.0	<i>S.B. from London</i> (9.25 Local News) (Continued on page 122.)	
8.0	<i>S.B. from London</i>							
9.10	Shipping Forecast							
9.15-12.0	<i>S.B. from London</i>							



# NATIONAL CONCERT PROGRAMME (January 20)

## PROGRAMME NOTES.

### REQUIEM MASS.

IN 1836, the French Government decided to make an annual grant of three thousand francs to some Composer (a different man every year) who should write a new Mass or Oratorio. The first commission was given to Berlioz, who tells how he had 'long coveted the text of the *Requiem* as his prey.' He 'fell upon it with a sort of frenzy,' and ideas came so fast that he 'had recourse to a system of shorthand.'

The first performance of the work was given at the Church of the Invalides on the occasion of a military memorial service. The music produced 'a tremendous impression,' the Composer tells us in his *Memoirs*. At the *Tuba mirum* 'the startling effect produced by the five orchestras and the eight pairs of Kettledrums was beyond description. One of the choristers fell down in a fit.' (One cannot help feeling that to Berlioz, with his love for the sensationally dramatic, that fit ranked high amongst the tributes paid to the work!)

The 'five orchestras' refers to the addition to the score of four bodies of brass instrument players. In addition, what may be called the 'normal' orchestral force is largely augmented, and the choral work is in six parts.

Sir Hamilton Harty has recently revived the work in Manchester. It has only been heard once in London—at the Crystal Palace, thirty years ago.

The various sections of the work are as follows (the English translation being a more or less free rendering):—

1. REQUIEM AND KYRIE. 'Requiem aeternam dona eis, Domine, et lux perpetua luceat eis . . . Kyrie eleison, Christe eleison, Kyrie eleison.' ('Eternal rest give to them, O Lord, and let perpetual light shine upon them . . . Lord, have mercy upon us; Christ, have mercy upon us; Lord, have mercy upon us.')

2. DIES IRAE. 'Dies irae, dies illa . . . ('Day of wrath, that dreadful day . . .') 'Tuba mirum spargens sonum per sepulchra regionum . . . ('Wondrous sound the trumpet scattereth through the sepulchral regions') . . . 'Judex ergo cum sedebit . . . nil inultum remanebit' ('When the Judge takes his seat . . . nothing remains concealed').

3. QUID SUM MISER. 'Quid sum miser tunc dicturus?' ('What then shall I, frail man, plead?') . . . 'Recordare Jesu pie, quod sum causa tuae viae' ('Remember, good Jesus, that I am the cause of Thy Incarnation').

4. REX TREMENDAE. 'Rex tremendae majestatis, qui salvandos salvas gratis, salva me, Iona pietatis . . . ('Great King of Majesty, who dost free salvation send us, Fount of pity, save me').

5. QUAErens ME. 'Quaerens me sedisti lassus . . . ('Thou hast sought me, faint and weary').

6. LACHRYMOSA. 'Lachrymosa dies illa, qua resurget ex favilla judicandus homo reus.' ('Ah, that day of tears, when man, from the dust of earth returning, must prepare for judgment.')

7. OFFERTORIUM. 'Domine Jesu Christe, Rex gloriae, libera animos omnium fidelium defunctorum de poenis inferni . . . ('Lord Jesus Christ, King of Glory, deliver the souls of all the faithful departed from the pains of hell . . .').

8. HOSTIAS. 'Hostias e preces tibi, Domine, laudis offerimus . . . ('We offer Thee with praises, O Lord, sacrifice and prayers . . .').

9. SANCTUS. 'Sanctus, Sanctus, Sanctus, Deus Sabaoth . . . ('Holy, holy, holy, Lord God of Sabaoth . . .').

10. AGNUS DEI. 'Agnus Dei, qui tollis peccata mundi, dona eis requiem sempiternam . . . ('O Lamb of God, that takest away the sins of the world, grant them eternal rest . . .').



BERLIOZ.

Taken from a statue erected to his memory at Côte St. André.

### THE B.B.C. NATIONAL CONCERTS

SIXTH CONCERT

Relayed from the Royal Albert Hall.

#### BERLIOZ PROGRAMME

THE NATIONAL ORCHESTRA  
THE HALLÉ CHORUS  
FOUR BRASS ORCHESTRAS

Drawn from THE BESSÉS O' THE BARN  
AND IRWELL SPRINGS BANDS

Conducted by Sir HAMILTON HARTY

8.0 PART I  
Requiem (Messe des Morts).  
Tenor Solo: TUDOR DAVIES

9.15 Interval

9.35 PART II  
Overture, 'The Corsair'  
Royal Hunt and Storm in the Forest  
(The Trojans)  
Dance of the Will-o'-the-Wisps } (Faust)  
Rakoczký March



Lafayette

Sir HAMILTON HARTY.

### OVERTURE, 'THE CORSAIR.'

BERLIOZ is not known to have left any indications whatever of any literary or pictorial intentions in his Overture, *The Corsair*. It seems obvious that he aimed at no musical 'interpretation' of either whole or part of Byron's richly-detailed romantic Poem, but rather at a character-study of this fierce pirate chief, the *Corsair*, in whom Byron has been supposed to depict himself under the guise of the adventurer who seeks forgetfulness in the intoxication of the fight.

An interesting point has been established, that the writing of this Overture was suggested to Berlioz by a stormy sea-voyage he himself made. Some of the slower, more tranquil passages have been considered as a suggestion of the *Corsair's* beloved, Medora; on the other hand, they may rather belong rightly to the romanticism and mystery, even mysticism, of the sea.

Berlioz' Overture is nominally in 'First Movement' form, but is highly developed for its day. For instance, the rushing Strings' scale-passages, and the calm, expressive melody of the Introduction, are important constituents, as they stand, of the whole work. And instead of anything even remotely suggestive of mere recapitulation, development continues right through to the end of the Overture.

### ROYAL HUNT AND STORM IN THE FOREST, FROM 'THE TROJANS.'

JUST over sixty years ago Berlioz produced the Opera from which this piece is an extract.

This 'Symphonic Entr'acte' represents a scene in 'a virgin forest in the neighbourhood of Carthage.' Naiads appear, and bathe. The hunt is heard in the distance, gradually getting nearer, and the naiads vanish. Various hunters cross the scene. A storm approaches. While the storm increases, Ascanias, son of Aeneas, gallops past, followed by other huntsmen. The storm approaches its height, and night falls. Dido and Aeneas, hunting, arrive and take refuge in a cave.

Wood Nymphs appear, singing, also Fauns and Satyrs, all of whom dance a grotesque dance in the darkness. A little stream in the rocks becomes a noisy cataract. Lightning strikes a tree, and, finally, the whole scene is obscured by dense clouds. The storm at last abates and the clouds scatter.

The music calls for no description. The above conveys its spirit.

### DANCE OF THE WILL-O'-THE-WISPS AND RAKOCZKY MARCH, FROM 'FAUST.'

WHEN, in 1827, a French translation of Goethe's *Faust* appeared, Berlioz, fascinated by the work, set part of it to music, and then, poor as he then was, had this engraved at his own cost, as *Eight Scenes from Faust*. Twenty years later, he recast and greatly added to his work, and published it as *The Damnation of Faust*. Though it was not originally intended for the stage, it is sometimes performed as an Opera.

The Minuet of the Will-o'-the-Wisps occurs at that point in the plot where Mephistopheles, before Margaret's dwelling, calls up the fleeting spirits of flame and commands them to dance.

There was no Rakoczký March in the first version of *Faust*. In 1846 Berlioz was visiting Buda-Pesth, and on the advice of a friend picked out from a collection a national air (it may or may not be a folk-tune), and worked it up into this March to please the Hungarians. It went so well that he introduced it into *Faust*, 'taking the liberty,' as he said, 'of putting Faust in Hungary, and making him witness the passage of a Hungarian army across the plain.'

# BULLPHONE

So great was the reception accorded our offer of 5,000 Units at 15/- each that we are pleased to state that they were oversold in the first 2 days. WE HAVE THEREFORE DECIDED TO CONTINUE THIS AMAZING OFFER UNTIL FURTHER NOTICE PURELY AS AN ADVERTISEMENT.

## GRAMOPHONE ATTACHMENTS

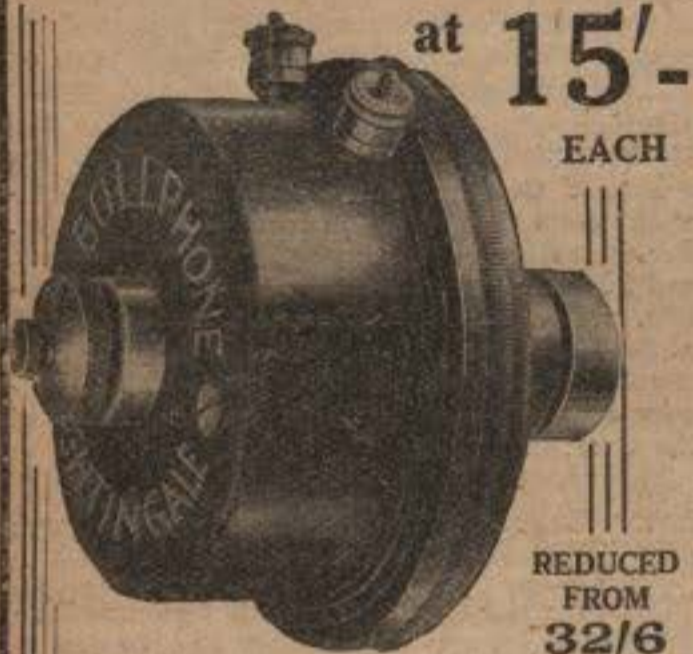

at **15/-**  
EACH

REDUCED  
FROM  
**32/6**

FROM YOUR LOCAL DEALER  
OR SEND CASH WITH ORDER  
DIRECT TO US.

This attachment is the identical unit fixed to our £3 and £6 Super Loudspeakers, and is the original non-metallic sound unit which is being extensively copied by many well-known manufacturers, proof enough of the superiority of the Bullphone. Originally priced at 32/6, now offered at 15/- as an advertisement.

## NIGHTINGALE LOUDSPEAKERS for CASH or EASY TERMS



60/-  
CASH

will not overload 2 to 10 valves. Absolutely free from all distortion and the last word in construction. Guaranteed superior to others regardless of price.

**5/-** SECURES  
THIS  
SUPER  
LOUD-  
SPEAKER

and 12 monthly payments of 5/- complete purchase, or can be purchased post free for 60/- cash. Specification: Full size, 21" high, Bell mouth 14", strong, handsome, nickel-plated ten-arm and stand, with black crystal bell head as illustrated.

Ask your dealer to demonstrate "Bullphone" Loudspeakers, or send your orders direct to the manufacturer, address below.

**W. BULLEN,**  
38, Holywell Lane, E.C.2.

# PROGRAMMES FOR THURSDAY (January 20)

(Continued from page 120.)

## 6KH HULL. 288.5 M.

- 11.30-12.30 Gramophone Records  
4.0 AFTERNOON TOPICS: Mrs. R. W. GUNSTON, 'Laundry in the Home'  
4.15 FIELD'S QUARTET, relayed from the New Restaurant, King Edward Street  
5.15 THE CHILDREN'S HOUR  
6.0 London programme relayed from Daventry  
6.15 S.B. from London  
7.0 Dr. G. J. JORDAN, 'The French Revolution—(2) The Course'  
7.15 S.B. from London  
7.45 S.B. from Manchester  
8.0-12.0 S.B. from London (9.25 Local News)

## 2LS LEEDS-BRADFORD. 277.8 M. & 274.2 M.

- 11.30-12.30 FIELD'S CAFÉ ORCHESTRA, relayed from Field's Café, Commercial Street, Leeds  
4.0 FIELD'S CAFÉ ORCHESTRA  
5.0 THE LORD MAYOR'S CHILDREN'S PARTY  
RELAYED FROM THE TOWN HALL, LEEDS  
A Special Concert will be given by many of the Artists appearing in the Leeds Pantomimes.  
6.0 Light Music  
6.15 S.B. from London  
6.45 FOR SCOUTS: R. L. MATTHEWS, Chief Constable of Leeds, 'How a Police Constable is Trained'  
7.0 S.B. from London  
7.45 S.B. from Manchester  
8.0-12.0 S.B. from London (9.25 Local News)

## 6LV LIVERPOOL. 297 M.

- 4.0 HAROLD GEE and his ORCHESTRA, from the Trocadero Cinema  
5.0 Readings by H. C. Pearson  
5.15 THE CHILDREN'S HOUR  
6.0 Trocadero Cinema Music (continued)  
6.15 S.B. from London  
6.45 BOYS' ASSOCIATION MONTHLY TALK: MAJOR J. BENNETT, 'Boxing in Boys' Clubs'  
6.55 Girls' Clubs Monthly Talk  
7.0 S.B. from London  
7.45 S.B. from Manchester  
8.0-12.0 S.B. from London (9.25 Local News)

## 5NG NOTTINGHAM. 275.2 M.

- 11.30-12.30 Morning Concert relayed from Daventry  
2.40 BROADCAST TO SCHOOLS: Professor H. H. SWINNERTON, 'The Geography of Nottingham and its Little Sisters. (1) Their Hills and Valleys'  
3.0 London Programme relayed from Daventry  
4.0 AFTERNOON CONCERT OF LIGHT MUSIC, with IDA SARGENT in Songs at the Piano  
5.15 THE CHILDREN'S HOUR  
6.15 S.B. from London  
7.0 Mr. E. CAREY-RIGGALL: 'Fast Snakes and Slow Worms'  
7.15 S.B. from London  
7.45 S.B. from Manchester  
8.0-12.0 S.B. from London (9.25 Local News)

## 5PY PLYMOUTH. 400 M.

- 11.0-12.0 GEORGE EAST and his QUARTET relayed from Popham's Restaurant  
3.30 ORCHESTRA from Popham's Restaurant  
4.0 AFTERNOON TOPICS  
4.15 TEA-TIME MUSIC: THE ROYAL HOTEL TRIO, directed by Albert Fullbrook  
5.15 THE CHILDREN'S HOUR  
6.0 JOHN DREW (Dialect Stories)  
6.15 S.B. from London  
7.0 Dr. HERBERT FISHER: 'Some Characteristics of Sullivan's Music' (2)  
7.15 S.B. from London  
7.45 S.B. from Manchester  
8.0-12.0 S.B. from London (9.25 Local News)

## 6FL SHEFFIELD. 272.7 M.

- 3.25 BROADCAST TO SCHOOLS: Mr. R. E. SOPWITH, 'Books Worth Reading' (1)  
4.0 Afternoon Topics  
4.15 Organ relayed from the Albert Hall  
5.15 THE CHILDREN'S HOUR  
6.0 Musical Interlude  
6.15 S.B. from London  
7.0 Mr. W. J. HADFIELD, The City Surveyor: 'How Sheffield City Departments Work'  
7.15 S.B. from London  
7.45 S.B. from Manchester  
8.0-12.0 S.B. from London (9.25 Local News)

## 6ST STOKE. 288.5 M.

- 2.30 London programme relayed from Daventry  
5.15 THE CHILDREN'S HOUR  
6.0 Light Music  
6.15 S.B. from London  
7.0 Mr. A. J. DALE, 'Industrial Series—(3) Production of Firebricks—Past, Present, and Future'  
7.15 S.B. from London  
7.45 S.B. from Manchester  
8.0-12.0 S.B. from London (9.25 Local News)

## 5SX SWANSEA. 288.5 M.

- 11.30-12.30 Gramophone Records  
2.30 London programme relayed from Daventry  
4.0 The J. W. BARLOW TRIO: ROSALIND DAYMOND (Contralto); EDITH HUNTER (Solo Pianoforte)  
5.15 THE CHILDREN'S HOUR  
6.0 Musical Interlude  
6.15 S.B. from London  
7.0 Mr. W. N. MEDLICOTT, 'The Birth of Jugoslavica—The Bosnian Crisis (1908-9)'  
7.15 S.B. from London  
7.45 S.B. from Manchester  
8.0-12.0 S.B. from London (9.25 Local News)  
(Northern Programmes for Thursday in summary form appear on page 128.)

# PROGRAMMES FOR FRIDAY (January 21)

## 2LO LONDON. 361.4 M.

- 1.0-2.0 Lunch-Time Music from the Hotel Metro-pole
- 3.20 M. STÉPHAN, 'Elementary French'
- 3.45 CONCERT FOR SCHOOL CHILDREN  
Arranged by the PEOPLE'S CONCERT SOCIETY in co-operation with the B.B.C.  
FIRST CONCERT OF FIFTH SERIES  
This is the first of three programmes, the first parts of which will feature works by John Sebastian Bach (1685-1750)
- THE PEOPLE'S CONCERT ORCHESTRA  
Conductor, CHARLES WOODHOUSE  
Principal Violin, GEORGE STRATTON  
Solo Flute, ROBERT MURCHIE  
Gayotte from Suite in D (arranged for String Orchestra by Charles Woodhouse) ..... Bach  
Movements from Suite in B Minor, for Flute and Strings ..... Bach  
Rondo; Two Bourrees; Polonaise; Badinerie  
Bourree in G (from Suite newly arranged by Charles Woodhouse) ..... Bach
- The second part of the programme will include miscellaneous items, the titles of which will be given out by the Announcer.
- 4.45 THE WEBSTER NORCROSS QUARTET  
Round the World Medley ..... arr. Norcross  
Lull Me to Sleep, ye Winds ..... Kidner  
Coon Song, 'Cotton Dolly' ..... Geibel  
Feasting I Watch ..... Elgar  
Whose Gon Bring Your Chickens arr. Van Lennep
- 5.15 THE CHILDREN'S HOUR: Harp Solos by SIDONIE GOOSSENS, 'The Expedition to the North Pole' (A. A. Milne)
- 6.0 FRANK WESTFIELD'S ORCHESTRA from the Prince of Wales Playhouse, Lewisham
- 6.30 WEATHER FORECAST, FIRST GENERAL NEWS BULLETIN
- 6.45 FRANK WESTFIELD'S ORCHESTRA (Continued)
- 7.0 Mr. PERCY SCHOLES, the B.B.C. Music Critic
- 7.15 THE FOUNDATIONS OF MUSIC  
Bach's 48 Preludes and Fugues  
Played through consecutively at this hour daily throughout the month
- 7.25 Topical Talk
- 7.45 VOICE AND PERSONALITY—III.  
Special Test, conducted by Professor T. H. PEAR (Professor of Psychology, Manchester University). S.B. from Manchester (See special article on page 101)
- 8.0 THE DOGMERSFIELD TOY SYMPHONY BAND in Toy Symphonies and Dance Music
- 8.30 Reading of  
WORDSWORTH'S AND BYRON'S POEMS  
by MARY SOMERVILLE and H. S. EDE
- 8.45 THROUGH ANOTHER'S EYES  
Played by ADOLPHE HALLIS  
CHINA (as seen by a Frenchman)  
Pagodas ..... Debussy  
ANNAM (as seen by a Frenchman)  
Annamese March ..... Paul Dupin  
RUSSIA (as seen by two Englishmen)  
In a Vodka Shop ..... Arnold Bax  
Russian Dance ..... Cyril Scott
- 9.0 WEATHER FORECAST, NEWS; Local News
- 9.15 Topical Talk
- 9.30 A FAREWELL RECITAL  
by STUART ROBERTSON (Bass)  
Bright is the Ring of Words Vaughan Williams  
Bonnie George Campbell ..... Frederick Keel  
Take, O Take Those Lips Away .. Roger Quilter  
Love is a Babel ..... Hubert H. Parry

DAME NELLIE MELBA has specially chosen Mr. Stuart Robertson to accompany her on her forthcoming Australian Farewell Tour—a high honour for so young a singer. Mr. Robertson's broadcasts during the last two years have done a great deal to earn for him his reputation as one of the most promising of young English singers.

9.50 NORMAN O'NEILL  
Conducting a Programme of his Music, with GEORGE BAKER (Baritone) and THE WIRELESS ORCHESTRA  
Overture Humoresque  
La Belle Dame Sans Merci (Keats)—Ballad for Baritone and Orchestra.  
(Soloist: GEORGE BAKER)  
Four Dances (The Blue Bird)

NORMAN O'NEILL is an Irishman who studied music in London (under Dr. Arthur Somervell) and at Frankfurt, and has leanings towards French culture.



E. O. Hoppe

Mr. NORMAN O'NEILL,

who is conducting a programme of his own music which will be heard from London this evening at 9.50. All theatre-goers will remember Mr. O'Neill as the composer of the delightful incidental music to 'The Blue Bird' and Sir James Barrie's 'Mary Rose.'

10.20 app. 'TAKING THE LIBERTY'  
A Comedy in One Act by W. P. LIPSCOMB  
Characters:  
Burton ..... GILBERT RITCHIE  
Bill ..... TRISTAN RAWSON  
Hardrada ..... HAROLD KIMBERLEY  
Ethel ..... DOROTHY TETLEY  
SCENE: Any sort of room that a bachelor with taste, any amount of leisure, and not a little money might reasonably be supposed to occupy. One could spend a most comfortable night in any of the great arm-chairs or the chesterfield; and, anyway, one couldn't wish for a better companion at any time than Bill, who is genial, suave, and deliberate throughout.

10.45-11.0 NORMAN O'NEILL PROGRAMME (Continued)  
ORCHESTRA  
Irish Folk-Songs  
Punch and Judy Ballet (The Punch Bowl)

## 5XX DAVENTRY. 1,600 M.

- 10.30 a.m. TIME SIGNAL, WEATHER FORECAST
- 11.0 THE DAVENTRY QUARTET and MARGARET STEPHEN (Soprano); J. SE MORAES (Tenor); FREDERICK BURTON (Pianoforte)
- 12.30 ORGAN RECITAL, by WALTER S. VALE, A.R.A.M. (Organist and Director of the Choir,

All Saints, Margaret St., W.I., Professor at the Royal Academy of Music), with ELIZABETH NICHOLSON (Mezzo-Soprano). Relayed from St. Mary-le-Bow, Cheapside.

Fugue in G ..... J. L. Krebs  
Choral Preludes, Op. 122, Nos. 8 and 11 Brahms  
Es ist ein' Nos' entsprungen  
O Welt, ich mass dich lassen  
ELIZABETH NICHOLSON  
Two Christmas Songs ..... Peter Cornelius  
Christ, the Friend of Children  
The Infant Christ  
Sketch in D Flat, Op. 58, No. 4 ..... Schumann  
Pastorale in E ..... Cesar Franck

- 1.0-2.0 S.B. from London
- 3.20 S.B. from London
- 7.45 S.B. from Manchester
- 8.0 S.B. from London
- 9.10 Shipping Forecast
- 9.15 S.B. from London
- 11.0-12.0 DANCE MUSIC: JACK PAYNE'S HOTEL  
CECIL DANCE BAND from the Hotel Cecil

## 5IT BIRMINGHAM. 491.8 M.

- 3.20 London Programme relayed from Daventry
- 3.45 THE STATION PIANOFORTE QUINTET: Leader, FRANK CANTELL
- 4.45 AFTERNOON TOPICS: ESTELLE STEEL HARPER, 'The Lily and Lotus in Art and Craft.' ANN SAUNDERS (Contralto)
- 5.15 THE CHILDREN'S HOUR: A Sunset Story (written by G. Bernard Hughes), told by JANET JOYE
- 6.0 HAROLD TURLEY'S ORCHESTRA, relayed from Prince's Café
- 6.30 S.B. from London
- 7.45 S.B. from Manchester
- 8.0 S.B. from London (9.10 Local News)
- 9.30-11.0 CHAMBER MUSIC  
THE BIRMINGHAM STATION STRING QUARTET  
FRANK CANTELL (Violin), ELSIE STEEL (Second Violin), ARTHUR KENNEDY (Viola), LEONARD DENNIS (Cello)  
String Quartet, Op. 18, No. 4, in C Minor  
Beethoven  
SAMUEL SAUL (Baritone)  
Unmindful of the Roses ..... Coleridge-Taylor  
In the Silent Night ..... Rachmaninov  
My Love Song ..... Under  
I Care Not for Those Ladies .... Campion, 1601  
QUARTET  
Three Movements from 'Lady Audrey's Suite'  
Howells  
'The Four Sleepy Golliwogs' Dance; The Little Girl and the Old Shepherd; The Old Shepherd's Tale  
SAMUEL SAUL  
Birds in the High Hall Garden .. } Somercell  
Go Not, Happy Day ..... }  
Dream Valley ..... Quilter  
False Phyllis ..... Lane Wilson  
QUARTET  
Molly On the Shore ..... Grainger

## 6BM BOURNEMOUTH. 326.1 M.

- 3.20 London Programme-relayed from Daventry
- 4.45 E. GEE NASH, 'Translations from Foreign Literature—(2) A Story from the French'
- 5.0 THE STATION TRIO
- 5.15 THE CHILDREN'S HOUR
- 6.0 THE STATION TRIO
- 6.30 S.B. from London
- 7.45 S.B. from Manchester
- 8.0-11.0 S.B. from London (9.10 Local News)

# PROGRAMMES FOR FRIDAY (January 21)

## 5WA CARDIFF. 353 M.

- 3.20 London Programme relayed from Daventry  
 4.45 Mrs. MARY B. CROWLE, 'Typhoons'  
 5.0 TEA-TIME MUSIC from the Carlton Restaurant  
 5.15 THE CHILDREN'S HOUR  
 6.0 Mr. A. G. PRYS JONES, 'Appreciations of Well-Known Poems—(2) "The Ancient Mariner," by Coleridge'  
 6.15 LIGHT MUSIC from the Carlton Restaurant  
 6.30 S.B. from London  
 7.45 S.B. from Manchester  
 8.0 S.B. from London  
 8.30 MY FAVOURITE SONGS—9  
 A Recital by KENNETH ELLIS (Bass)
- Si tra i ceppi (Berenice) ..... Handel  
 The Last Leaf ..... Sidney Homer  
 The Drum Major ..... Ernest Newton  
 The Pools of Silence ..... Maud Wingate  
 The Derby Ram ..... William F. Hurlstone  
 Droop Not, Young Lover ..... Handel  
 The Devout Lover ..... M. V. White  
 By a Bier-side ..... Armstrong Gibbs
- 9.0 S.B. from London (9.10 Local News)

### 9.30-11.0 FOOTBALL FEATS

A Programme for Sportsmen by Sportsmen

The Performers include:—

A. S. BURGE; HARRY HART; WALTER J. MARTIN; L. E. WILLIAMS and JACQUE THOMAS.

THE CAERPHILLY GLEEMEN; THE ST. SAVIOUR'S BAND; THE STATION ORCHESTRA

THIS programme is mainly built upon the historic encounter between Cardiff and the 'Springboks,' January 1, 1908.

No more popular combination than the 'SPRINGBOKS' (South African Rugby Team) of 1908, has toured these Isles. The name of Marsburg, the demon full-back, swiftly brings back the greatness of that team, which included Stegmann, Luyt, Joubert, Carol, Dobbin and the Brothers Morkel.

Scotland were the only International team to lower their colours, and that by a three-point margin. Wales suffered a distinct defeat by the 'Springboks,' but on New Year's Day, 1908, in a sea of mud, the Cardiff team was victorious by 17 points to nil.

It is this game, then, that we propose to play over again in a cameo written by L. E. WILLIAMS. Picture the ground rain swamped, and wind swept, packed with spectators roaring their delight at the brilliant play on both sides.

## 2ZY MANCHESTER. 384.6 M.

- 1.15-2.0 PIANOFORTE TRIO from the Piccadilly Picture Theatre
- 3.25 BROADCAST TO SCHOOLS: Mr. W. E. BURROWS, 'Travel Pictures of the British Empire—India—(1) To India and Up the Ganges'
- 3.45 JACOB FREEMAN (Dialect Entertainer)  
 Adam and Mary .....  
 Th' Owd Bellmon ..... } S. Laycock  
 Ode to 'Sun' ..... }
- 4.0 Music by THE STATION QUARTET  
 Valse, 'You and You' ..... Strauss  
 Ballet, 'The Sleeping Beauty' ..... Tchaikovsky  
 I Love Thee ..... Grieg  
 Erotik .....  
 Selection from 'Faust' ..... Berlioz
- 5.0 AFTERNOON TOPICS: Mrs. HELENA M. BLAND—'The Art of Giving'
- 5.15 THE CHILDREN'S HOUR
- 6.0 THE MAJESTIC 'CELEBRITY' ORCHESTRA from the Hotel Majestic, St. Anne's-on-the-Sea. Musical Director, GERALD W. BRIGHT
- 6.30 S.B. from London
- 6.45 THE MAJESTIC 'CELEBRITY' ORCHESTRA (Continued)
- 7.0 S.B. from London
- 7.45 VOICE AND PERSONALITY—III.  
 Special Test conducted by Prof. T. H. PEAR (Professor of Psychology, Manchester University)  
 (See special article on page 101)
- 8.0 'LANDING THE SHARK'  
 By VIVIAN TIDMARSH  
 Played by THE LONDON RADIO REPERTORY PLAYERS
- Cast:  
 Gerald Graystone (a Bucket-Shop Keeper)  
 HENRY OSCAR  
 Mary South (His Typist) ..... BARBARA COUPER  
 Thomas Bevan (a Detective) .. REGINALD DANCE
- In his office in the City, fitted with the usual safe, telephone, desks, and files, Gerald Graystone sits writing.
- 8.21 SHANTIES and ARMY SONGS  
 GEORGE HILL (Baritone) and CHORUS  
 Marching Song, 'John Brown's Body'

### Shanties:

My Tommy's Gone Away ..... }  
 The Banks of Sacramento ..... } arr. R. B. Terry  
 Sally Brown ..... }

Hullabaloo Balay ..... arr. Taylor-Harris

### Camp Songs:

Clementine ..... P. Montross  
 Cock Robin ..... arr. J. K. L.  
 Tarpaulin Jacket ..... arr. C. Coote  
 John Peel ..... arr. J. Tait

### Shanties:

We're All Bound to Go ..... }  
 Lowlands Away ..... }  
 Johnny Come Down to Hilo .. } arr. R. E. Terry  
 What Shall We Do With the }  
 Drunken Sailor? .. }

### Marching Songs:

Mademoiselle from Armentières .. arr. T. K. Fell  
 Lillibullero ..... Reginald Paul

9.0 S.B. from London (9.10 Local News)

### 9.50-11.0 MENDELSSOHN

(Chamber Music and Song)

ETHEL DAVISON (Soprano)

Welcome to Spring; Summer Days are Coming;  
 The Garland, and New Love

THE BRITISH TRIO: ALFRED BARKER (Violin),  
 CLYDE TWELVETREES (Cello), JOHN WILLS  
 (Piano)

Trio in D Minor, Op. 49

Molto Allegro; Andante Con Moto; Scherzo;  
 Allegro Assai Appassionata

ETHEL DAVISON

The Violet; Romance, and On Wings of Song

TRIO

Trio in C Minor, Op. 66

## 6KH

## HULL.

## 288.5 M.

11.30-12.30 Gramophone Records

3.30 BROADCAST TO SCHOOLS: K. GRAHAM THOMPSON, 'How Our History Grew—(1) The Influence of Coal'

4.0 Afternoon Topics

4.15 FIELD'S QUARTET, relayed from the New Restaurant, King Edward Street

5.15 THE CHILDREN'S HOUR

6.0 London Programme relayed from Daventry

6.15 Mr. J. G. STEPHENS: Weekly Football Talk

6.30 S.B. from London

7.45 S.B. from Manchester

8.0-11.0 S.B. from London (9.10 Local News)



Mr. GEORGE HILL will sing some Sea Shanties and Army Songs in to-night's programme from Manchester.



THE BRITISH TRIO, Alfred Barker (violin), Clyde Twelvetrees (cello), and John Wills (piano), will play Mendelssohn's two trios from Manchester to-night [9.50].



Mr. SAMUEL SAUL, baritone, will be heard during this evening's Concert of Chamber Music from Birmingham [9.30].

# PROGRAMMES FOR FRIDAY (January 21)

## 2LS LEEDS-BRADFORD. 277.8 M. & 254.2 M.

- 11.30-12.30 FIELD'S CAFÉ ORCHESTRA
- 3.20 BROADCAST TO ELEMENTARY SCHOOLS: MR. HERBERT BARDGETT, 'Musical Appreciation—(2) Hidden Tunes'
- 4.0 BROADCAST TO SECONDARY SCHOOLS: DR. C. B. FAWCETT, 'Weather and Climate'
- 4.30 THE LEEDS-BRADFORD LIGHT SYMPHONY ORCHESTRA, relayed from Fenton Street Drill Hall, Leeds, on the occasion of the Yorkshire Post Building Trades Exhibition
- 5.0 AFTERNOON TOPICS: MISS M. M. HUMMERSTON, 'Dancers and Dancing'
- 5.15 THE CHILDREN'S HOUR
- 6.0 Light Music
- 6.30 S.B. from London
- 7.45 S.B. from Manchester
- 8.0-11.0 S.B. from London (9.10 Local News)

## 6LV LIVERPOOL. 297 M.

- 3.15-3.45 BROADCAST TO SCHOOLS: MR. J. J. SIMPSON, 'The Economic Uses of Animal Products—(1) Sponges and Pearls'
- 4.0 GAILLARD and his ORCHESTRA, from the Scala
- 5.0 AFTERNOON TOPICS: KATE LOVELL, 'Snow and Frost'
- 5.15 THE CHILDREN'S HOUR
- 6.0 THE STATION PIANOFORTE QUARTET
- 6.30 S.B. from London
- 7.45 S.B. from Manchester
- 8.0 'LANDING THE SHARK'—A Play: (See Manchester Programme)
- 8.21 S.B. from Manchester
- 8.45-11.0 S.B. from London (9.10 Local News)

## 5NG NOTTINGHAM. 275.2 M.

- 11.30-12.30 Concert relayed from Daventry
- 3.45 LYONS' CAFÉ ORCHESTRA, conducted by BRASSEY EYTON
- 4.45 MUSIC and AFTERNOON TOPICS
- 5.15 THE CHILDREN'S HOUR
- 6.15 MABEL HODGKINSON (Pianoforte)
- 6.30 S.B. from London
- 7.45 S.B. from Manchester
- 8.0-11.0 S.B. from London (9.10 Local News)

## 5PY PLYMOUTH. 400 M.

- 3.30 ORCHESTRA from Pophan's Restaurant
- 4.0 AFTERNOON TOPICS: MR. ALBERT P. STEER, 'Photographing Animals'
- 4.45 TEA-TIME MUSIC: THE ROYAL HOTEL TRIO, directed by ALBERT FULLBROOK
- 5.15 THE CHILDREN'S HOUR
- 6.0 THE STATION TRIO
- 6.30 S.B. from London
- 7.45 S.B. from Manchester
- 8.0-11.0 S.B. from London (9.10 Local News)

## 6FL SHEFFIELD. 272.7 M.

- 11.30-12.30 Gramophone Dance Records
- 4.0 Afternoon Topics
- 4.15 MARION MACMILLAN ('Cello) and GEORGE JEFFERSON (Piano), MADGE MACMILLAN (Reciter)
- 5.15 THE CHILDREN'S CORNER
- 6.0 Musical Interlude
- 6.30 S.B. from London
- 7.45 S.B. from Manchester
- 8.0-11.0 S.B. from London (9.10 Local News)

## 6ST STOKE. 288.5 M.

- 3.20 BROADCAST TO SCHOOLS: MR. E. SIMS-HILDITCH, 'The Music of Russia'
- 3.45 London Programme relayed from Daventry
- 5.0 AFTERNOON TOPICS: LEON FORRESTER, 'Some Favourite Composers—(2) Mendelssohn'
- 5.15 THE CHILDREN'S HOUR
- 6.0 Light Music
- 6.30 S.B. from London
- 7.45 S.B. from Manchester
- 8.0-11.0 S.B. from London (9.10 Local News)

## 5SX SWANSEA. 288.5 M.

- 3.20 BROADCAST TO SCHOOLS: MR. B. PERROTT, 'Our Neighbours in Space'
- 3.45 London Programme relayed from Daventry
- 5.15 THE CHILDREN'S HOUR
- 6.0 A Short Lecture-Recital by T. D. JONES
- 6.30 S.B. from London
- 7.45 S.B. from Manchester
- 8.0 S.B. from London
- 8.30 S.B. from Cardiff
- 9.0 S.B. from London (9.10 Local News)
- 9.30-11.0 S.B. from Cardiff

## Northern Programmes.

### 5NO NEWCASTLE. 312.5 M.

- 3.0—Mr. T. Russell Goddard. 3.20—From Daventry. 5.0—Miss Agnes Strong. 5.15—Children's Hour. 6.0—John Newman (Entertainer) and Adam Nockels (Tenor). 6.30—S.B. from London. 7.45—S.B. from Manchester. 8.0-11.0—S.B. from London.

### 5SC GLASGOW. 405.4 M

- 11.30-12.30—Gramophone Records. 3.0—Dance Music. 3.20—Mr. Seton Gordon. 3.32—M. Albert le Grip. 3.45—For Schools. 3.55—Wireless Quartet and Peter Kane (Bass). 5.0—Afternoon Topics. 5.15—Children's Hour. 5.58—For Farmers. 6.0—Dance Music. 6.30—S.B. from London. 7.45—S.B. from Manchester. 8.0—S.B. from London. 9.30—Alexander McCredie (Tenor). 9.50—Station Choir. 10.0—J. B. Dickson. 10.15—Con Conrad (The American Composer). 10.30-11.0—Station Choir (Continued). J. B. Dickson.

### 2BD ABERDEEN. 500 M.

- 3.30—The Rev. A. Austin Foster. 3.45—Orchestra and Mlle. Madeleine Marot. Jean B. Emelle (Soprano). 5.15—Children's Hour. 6.0—The Rev. Charles E. Forster. 6.15—For Farmers. 6.25—Agricultural Notes. 6.30—S.B. from London. 6.45—Mr. Peter Craigmyle. 7.0—S.B. from London. 7.45—S.B. from Manchester. 8.0—S.B. from London. 8.30—Parry Jones (Tenor). 9.0—S.B. from London. 9.30-11.0—The Radio Concert Party present a Third Edition of 'Bon-Accord Nights.'

### 2BE BELFAST. 305.1 M.

- 11.0-1.0—From Daventry. 3.0—Prof. R. M. Henry. Claude de Ville (Pianoforte Recital Series). 3.45—Relayed from Daventry. 4.45—Records. 5.0—Afternoon Topics. 5.15—Children's Hour. 6.0—Orchestra. 6.30—S.B. from London. 7.45—S.B. from Manchester. 8.0-11.0—S.B. from London.



The Tonic that enriches the blood... Stimulates the circulation... and gives you new vitality.

LARGE BOTTLE, 5/-

Unequaled in Convalescence, Anæmia, Depression, Debility, Nerve Troubles, and every case of weakness.

## Hall's Wine

THE SUPREME TONIC RESTORATIVE

Of all Wine Merchants and Grocers and Chemists with Wine Licences.

Stephen Smith & Co., Ltd., Bow, London, E.3.



Get a grip on the Future!

THIS HOLDS GOOD

Whether it's a marriage portion, Education for the youngsters, A Business of your own, or Protection for those dependent upon you.

PROVIDE NOW out of income without undue financial strain. Get into touch with the nearest representative of

THE PRUDENTIAL ASSURANCE COMPANY LTD

write to:-

Chief Office: Holborn Bars, E.C.1.



# PROGRAMMES FOR SATURDAY (January 22)

## 5IT BIRMINGHAM. 491.8 M.

3.45 HAROLD TURLEY'S ORCHESTRA, relayed from Prince's Café

4.45 AFTERNOON TOPICS: MABEL FRANCE, 'If We Lived in the Palace of Truth'

5.15 THE CHILDREN'S HOUR: Another 'Snooky' Story

6.0 LOZELLS PICTURE HOUSE ORCHESTRA, conducted by PAUL RIMMER

Entr'acte, 'The Coster's Wooing'..... Rimmer  
Selection, 'A Day in Paris'..... Finck  
Galopade, 'Café Chantant'..... Fletcher  
One-step, 'Toledo'..... Padilla

6.30 S.B. from London

### 7.45 SHAKESPEAREAN HOUR

Selections from:

'A WINTER'S TALE'  
'JULIUS CAESAR'  
'HAMLET' and  
'OTHELLO'

Will be presented by WILLIAM MACREADY and EDNA GODFREY-TURNER

Between the Scenes Shakespearean Songs will be sung by GERTRUDE DAVIES (Soprano)

8.45 S.B. from London (9.10 Local News)

### 9.30 POPULAR MUSIC

THE STATION ORCHESTRA, conducted by JOSEPH LEWIS

Overture, 'The Homeland' ('La Patrie') Bizet

THIS Overture was one of the early successes of Bizet, the Composer of the Opera *Carmen*. It was first performed in 1874, when France was still bowed down by misfortune, and any call to patriotism throbbed in her heart. The music of *La Patrie* is scored for a large Orchestra, with much use of Brass and Percussion. The melodies are vigorous and tender by turns, and the orchestral colouring is vivid.

MIRANDA SUGDEN (Soprano) and Orchestra  
Valse Song, 'Romeo and Juliet'..... Gounod  
Nymphs and Fauns..... Bemberg

ORCHESTRA

Selection from 'Les Cloches de Corneville'  
*Planquette, arr. Golfrey and Hilberstadt*

MIRANDA SUGDEN

Hefle Cuckoo Fair..... Easthope Martin  
One Morning Very Early..... Sanderson

ORCHESTRA

Selection from 'The Arcadians'  
*Monckton and Talbot*

10.30-12.0 S.B. from London

## 6BM BOURNEMOUTH 326.1 M.

11.15-12.15 MIDDAY MUSIC, relayed from Beale's Restaurant, Old Christchurch Road, directed by GILBERT STACEY

4.0 THE ROYAL BATH HOTEL DANCE BAND, relayed from the King's Hall Rooms, directed by ALEX WAINSWRIGHT

5.0 London Programme relayed from Daventry

5.15 THE CHILDREN'S HOUR

6.0 THE STATION TRIO

6.30 S.B. from London

## 7.45 A VARIED HOUR

THE STATION OCTET

Overture to 'The Bohemian Girl'.....Balfé

7.55 JANE CROFT and ERNEST GROOM  
In Songs and Duets from their Repertoire

8.3 OCTET

Entr'actes:

'Babilage'.....  
'Loin de Bal'..... } Gillet

8.8 JANE CROFT and ERNEST GROOM  
In Songs and Duets

8.16 OCTET

Selection from 'Cavalleria Rusticana'  
*Mascagni, arr. Tavan*



Mr. Ernest Groom and Miss Jane Croft, whom Bournemouth listeners will hear at 7.55 this evening in Songs and Duets.

8.30 JANE CROFT and ERNEST GROOM  
In further Songs and Duets

8.40 OCTET

Entr'acte, 'Carissima'.....Elyar

8.45 S.B. from London (9.10 Local News)

### 9.30 BOURNEMOUTH HUMOUR

THE STATION OCTET

Valse, 'The Blue Danube'.....Johann Strauss

9.40 GEORGE STONE (Entertainer)

9.47 THE 'RAINBOW FOLLIES' CONCERT PARTY:  
W. H. LESTER, EILEEN PETERS, MARJORIE STONE, HERBERT S. WINTERS, ENID SHAW, I. R. ETHERIDGE, BERTRAM CRIDDLE

10.17 GEORGE STONE

10.24 OCTET

Russian Cradle Song.....Krein

10.30-12.0 S.B. from London

## 5WA CARDIFF. 353 M.

3.0 London Programme relayed from Daventry

5.0 THÉ DANSANT. Music by the LONDON CHORDEANS, relayed from Cox's Café

5.15 THE CHILDREN'S HOUR

6.0 London Programme relayed from Daventry

6.30 S.B. from London

7.0 Mr. L. E. WILLIAMS, 'The World of Sport'

7.15 S.B. from London (9.10 Local News)

10.45 CON CONRAD

(The famous American Composer)  
In Some of his Latest Successes

11.0-12.0 S.B. from London

## 2ZY MANCHESTER. 384.6 M.

3.30 MATINÉE CONCERT: DANCE MUSIC: THE ELYSÉE FIVE from the Piccadilly Dance Salon

5.0 MARY KAY (Contralto)

When All was Young.....Gounod  
Silent Noon.....Vaughan Williams  
Know'st Thou That Dear Land?.....Thomas  
To Music.....Schubert

5.15 THE CHILDREN'S HOUR: Requests

6.0 Light Music

6.30 S.B. from London

6.50 For Scouts

7.0 S.B. from London

7.25 Mr. STACEY LINTOTT: Sports Talk

7.45-12.0 S.B. from London (9.10 Local News)

## 6KH HULL. 288.5 M.

4.0 AFTERNOON TOPICS: Mr. M. A. R. HORSPOLL, 'Drama through the Ages—(6) The Morality Plays'

4.15 FIELD'S QUARTET, relayed from the New Restaurant, King Edward Street

5.15 THE CHILDREN'S HOUR

6.0 London programme relayed from Daventry

6.30-12.0 S.B. from London (9.10 Local News)

## 2LS LEEDS-BRADFORD. 277.8 M. & 254.2 M.

11.30-12.30 FIELD'S CAFÉ ORCHESTRA, relayed from Field's Café, Commercial Street, Leeds

4.0 THE TROCADERO DANCE BAND, relayed from the Trocadero Ballroom, Bradford

5.0 Afternoon Topics

5.15 THE CHILDREN'S HOUR

6.0 Light Music

6.30-12.0 S.B. from London (9.10 Local News)

## 6LV LIVERPOOL. 297 M.

4.0 AFTERNOON TOPICS: A Nautical Talk, by MANNIN CRANE

4.15 MONTAGUE'S SYMPHONICS, relayed from the Edinburgh Café Ballroom

5.15 THE CHILDREN'S HOUR

5.45 'A SCENE FROM OLD LONDON'

A Play by C. E. HODGES, with Music

Cast:

John Oldfield.....J. P. LAMB  
Ben Oldfield.....WALTER SHORN  
Sally Oldfield.....DORIS GAMBELL  
Sir Charles Bentley.....HUGH H. FRANCIS  
Frank Marston.....PHILIP HEBBERT

The Scene is laid in the parlour of the Golden Grapes Tavern. Period, 1850. The time of day is early morning.

# PROGRAMMES FOR SATURDAY (January 22)

6.15 MONTAGUE'S SYMPHONICS, relayed from the Edinburgh Café Ballroom

6.30-12.0 S.B. from London (9.10 Local News)

**5NG NOTTINGHAM. 275.2 M.**

11.30-12.30 Gramophone Records

3.45 SAM G. ROSS and his BAND, relayed from the Palais de Danse

5.0 THE CHILDREN'S HOUR

6.15 MABEL HODGKINSON (Pianoforte)

6.30-12.0 S.B. from London (9.10 Local News)

**5PY PLYMOUTH. 400 M.**

11.0-17.0 GEORGE EAST and his QUARTET, relayed from Popturn's Restaurant

3.0 The Station Orchestra

4.0 Afternoon Topics

4.15 TEA-TIME MUSIC: THE ROYAL HOTEL TRIO, directed by ALBERT FULLBROOK

5.15 THE CHILDREN'S HOUR

6.0 FRED CAVENDISH (Entertainer)

6.30-12.0 S.B. from London (9.10 Local News)

**6FL SHEFFIELD. 272.7 M.**

4.15 ORCHESTRA relayed from the Grand Hotel

5.15 THE CHILDREN'S HOUR

6.0 Musical Interlude

6.30-12.0 S.B. from London (9.10 Local News)

**6ST STOKE. 288.5 M.**

3.20 London Programme relayed from Daventry

5.0 AFTERNOON TOPICS: FLORENCE M. AUSTIN, 'Five Fancies from Frocks—(2) Satin'

5.15 THE CHILDREN'S HOUR

6.0 Light Music

6.30-12.0 S.B. from London (9.10 Local News)

**5SX SWANSEA. 288.5 M.**

3.0 London Programme relayed from Daventry

5.15 THE CHILDREN'S HOUR

6.0 T. D. JONES (Solo Pianoforte)  
Sonata, No. 10 (Op. 14, No. 2) ..... Beethoven  
Barcarolle ..... Sterndale Bennett  
Evensong ..... Austin

6.30 S.B. from London

7.0 Dr. 'TEDDY' MORGAN: 'Welsh Rugby Football'

7.15 S.B. from London (9.10 Local News)

10.45 S.B. from Cardiff

11.0-12.0 S.B. from London

## Northern Programmes.

**5NO NEWCASTLE. 312.5 M.**

11.30:—May Welsh (Contralto), and Handel Batey (Boy Vocalist). 12.10-12.30:—Gramophone Records. 4.0:—Music from Tilley's Restaurant, Blackett Street. 5.0:—London Programme relayed from Daventry. 5.15:—The Children's Hour. 6.0:—The Station Octet. 6.30:—S.B. from London. 7.0:—Mr. John Kenner: 'Soccer'. 7.15:—S.B. from London. 10.30:—Dance Music: Tilley's Dance Band, relayed from the Grand Assembly Rooms. 11.15-12.0:—S.B. from London.

**5SC GLASGOW. 405.4 M.**

3.0:—Dance Music relayed from 'The Locarno.' 5.0:—Afternoon Topics: Mrs. Ida Kelsall, 'House Planning from the Housewife's Point of View.' 5.15:—The Children's Hour. 5.58:—Weather Forecast for Farmers. 6.0:—Dance Music relayed from 'The Locarno.' 6.15:—Radio Society Talk. 6.30:—S.B. from London. 7.25:—Sports Talk: 'Association Football' by an Old International. 7.45-12.0:—S.B. from London.

**2BD ABERDEEN. 500 M.**

3.45:—Afternoon Topics: Mrs. Lindsay Shepherd, 'Rubbing Shoulders with the World.' 4.0:—The Station Orchestra. 4.20:—Helen Campbell (Elocutionist) 4.30:—Orchestra. 4.50:—Helen Campbell. 5.0:—Orchestra. 5.15:—The Children's Hour. 6.0:—Music by The Station Orchestra. 6.30:—S.B. from London. 7.25:—S.B. from Edinburgh. 7.45-12.0:—S.B. from London.

**2BE BELFAST. 306.1 M.**

4.0:—Light Music: The Station Orchestra. Pauline Barke (Harp). Harry Dyson (Flute). 5.0:—Afternoon Topics: Mr. James A. Barlow, 'The Rivers of Antrim and Down.' 5.15:—The Children's Hour. 6.0:—The Station Dance Band. 6.30:—S.B. from London. 7.45:—Ulster Provincial Series, Lisburn. Programme arranged by Albert S. Brook. Introductory Talk by Mr. James Duff, Junr. (Member of the Urban District Council, Chairman of the Roads Committee). 7.50:—Joseph Gurl (Solo Violin). 8.3:—Eva Martin (Contralto). 8.8:—Joseph McNeice (Baritone). 8.17:—Joseph Gurl. 8.23:—Winifred Hanna (Soprano). 8.29:—David Williams (Tenor). 8.39:—Florence and Olivia Wilson: Duet for Two violins. 8.45:—S.B. from London. 9.30:—Band Concert. The Royal Ulster Constabulary Band (by permission of Mr. F. A. Britten, Commissioner of Police), conductor, Mr. George C. Ferguson. Joseph Glass (Baritone). 11.0-12.0:—S.B. from London.

## Thursday's Northern Programmes.

(Continued from page 122.)

**5NO NEWCASTLE. 312.5 M.**

2.30-3.0:—London Programme relayed from Daventry. 4.0:—May Conn (Pianoforte). Florence Hicks (Soprano). 5.0:—London Programme relayed from Daventry. 5.15:—Children's Hour. 6.0:—For Farmers: Prof. D. A. Gilchrist, 'Seasonable Notes.' 6.15:—S.B. from London. 7.0:—Prof. J. W. Bews, 'The South African Native.' 7.15:—S.B. from London. 7.45:—S.B. from Manchester. 8.0-12.0:—S.B. from London.

**5SC GLASGOW. 405.4 M.**

3.0:—Dance Music, relayed from the Piccadilly Dance Club. 3.20:—Broadcast to Schools: Dr. J. P. McHutchinson, 'Science in Everyday Life—Why Things Hold Together.' 3.32:—Mr. John Fainman, English Literature. 3.45:—Musical Item to Schools: 'Dance of the Hours' (Ponchielli). 3.55:—Wireless Quartet. Jeanne Pollock (Soprano). 5.0:—Afternoon Topics: Mr. Percy Gordon, A Miniature Lecture Recital, 'Haydn.' 5.15:—Children's Hour. 5.58:—Weather Forecast for Farmers. 6.0:—Dance Music, relayed from the Piccadilly Dance Club. 6.15:—S.B. from Edinburgh. 6.30:—Dance Music (continued). 6.39:—S.B. from London. 6.45:—Girl Guides' Bulletin. 7.0:—S.B. from Edinburgh. 7.15:—S.B. from London. 7.45:—S.B. from Manchester. 8.0-12.0:—S.B. from London.

**2BD ABERDEEN. 500 M.**

3.45:—Afternoon Topics: Mrs. M. G. Cameron, 'Progress in the Poultry Yard.' 4.0:—Radio Dance Quartet, directed by Alan Madisky. Annie S. Hay (Pianoforte). 5.15:—Children's Hour. 6.0:—Girls' Guild Bulletin. 6.15:—S.B. from Edinburgh. 6.20:—S.B. from London. 6.45:—Girl Guides' Bulletin. 7.0:—S.B. from Edinburgh. 7.15:—S.B. from London. 7.45:—S.B. from Manchester. 8.0-12.0:—S.B. from London.

**2BE BELFAST. 306.1 M.**

3.0:—Broadcast to Schools: Professor Alan MacKinnon, 'How to Enjoy Reading.' 4.0:—Station Orchestra: March, 'R.A.F.' (Walford Davies); Overture, 'Plymouth Hoe' (Ansell); Advance of the Tanks (Ewing); Overture, 'Private Ortheris' (Ansell). 4.28:—Ella McCann (Soprano). 4.40:—Orchestra: Selection, 'Madame Butterfly' (Puccini-Duvan); Waltz from 'Romeo and Juliet' (Gounod); 'The Witches' Dance' (Puccini-Mallares). 5.0:—Afternoon Topics: Mr. Samuel Leighton, 'The Story of the Londonderry Air.' 5.15:—Children's Hour. 6.0:—S.B. from London. 7.0:—Professor Dudd, D.A., 'Hobbies' (No. 6). 7.15:—S.B. from London. 7.45:—S.B. from Manchester. 8.0-12.0:—S.B. from London.

## FOR LISTENERS TO OPERA BROADCASTS.

THE fifth of the series of Operas to be broadcast from all stations is to be given on January 28. This time it is to be Flotow's Opera 'Martha.' Listeners are recommended to have a copy of the words of the Opera in front of them when listening to the broadcast. The form given below is arranged so that applicants may obtain either (1) single copies of the Libretto of 'Martha' (or of 'The Barber of Seville,' 'Rigoletto,' 'The Bohemian Girl,' and 'Faust,' which have already been broadcast) at 2d. each; (2) the complete series of twelve for 2s. (including those which have already been broadcast, but which will be of value in future broadcasts); or (3) the remaining eight of the series (including 'Martha,' but excluding operas already broadcast) for 1s. 4d.

1. Please send me \_\_\_\_\_ copy (copies) of the Libretto of 'Martha.'  
 " " " " " " " " " " " 'The Barber of Seville.'  
 " " " " " " " " " " " 'Faust.'  
 " " " " " " " " " " " 'Rigoletto.'  
 " " " " " " " " " " " 'The Bohemian Girl,' for which I  
 enclose \_\_\_\_\_ pence at the rate of 2d. per copy.

2. Application for the complete series (including 'Rigoletto,' 'The Bohemian Girl,' 'Faust,' 'The Barber of Seville,' and 'Martha').

Please send me \_\_\_\_\_ copy (copies) of each of the Opera Libretti as published. I enclose P.O. No. \_\_\_\_\_ or cheque, value \_\_\_\_\_ in payment at the rate of 2s. for the whole series, post free.

3. Application for the remaining eight of the Series (including 'Martha').

Please send me \_\_\_\_\_ copy (copies) of each of the remaining eight Libretti of the complete series. I enclose P.O. No. \_\_\_\_\_ or cheque value \_\_\_\_\_ in payment at the rate of 1s. 4d. each eight Libretti, post free.

PLEASE WRITE IN BLOCK LETTERS.

NAME \_\_\_\_\_

ADDRESS \_\_\_\_\_

Applications must be marked 'Libretti' on the envelope and sent, together with the remittance, to Broadcast Opera Subscription List, c/o B.B.C., Savoy Hill, London, W.C.2.

Additional names and addresses may be written on a separate sheet of paper, but payment for the additional subscriptions must, of course, be sent with the order. The Libretti will be sent singly as published to reach subscribers a few days before each Opera is broadcast.



**MARCONIPHONE**  
"Ideal" Transformer



Ratios  
2.7-1  
4-1  
6-1  
8-1

The most dependable and efficient Intervalve Transformer that human skill and ingenuity has yet devised. Price 25/- each.



**STERLING**  
**NON-PONG**  
**VALVE-HOLDER.**

Does away entirely with all microphonic noises and mechanical shocks, thereby increasing the life of the valve.

Price 2/9.

Adapter for use with above. Price 3/6.



**MARCONIPHONE**  
**VARIABLE RESISTANCE**

40,000 ohms, for Reaction Control, 500,000 ohms for Loud Speaker Control, 8/5.



**MARCONIPHONE**  
**SWITCH**

for breaking both high and low tension circuits, 3/6.



**MARCONIPHONE**  
**GRID LEAKS.**

.1, .25, .5, 1.0, 2.0, 3.0, 5.0, .05 capacity, 1/3 each. Mounted, 2/3.



**MARCONI**  
**D.E. 2 L.F.**  
**VALVE.**

Dull Emitter for two-volt accumulators. For early stages of Low Frequency Amplification. Can also be used as a rectifier with anode voltage 20-40. Price 14/-

The New  
**MARCONI**  
**D.E.P. 215**  
**VALVE.**

For 2-Volt  
Accumulators.

A 2-volt power amplifying valve for final stages of L.F. work, and will also serve as a det., with grid leak and condenser, with 40 volts H.T. The consumption is exceedingly low, less than 1/2 watt. Gives crystal-clearness with a wealth of volume. In every way a valve of distinctive merit.

Price 18/8.



An Efficient 4-Valve Long Range Model for Loud Speaker Reception constructed from

# Marconiphone and STERLING Radio Components

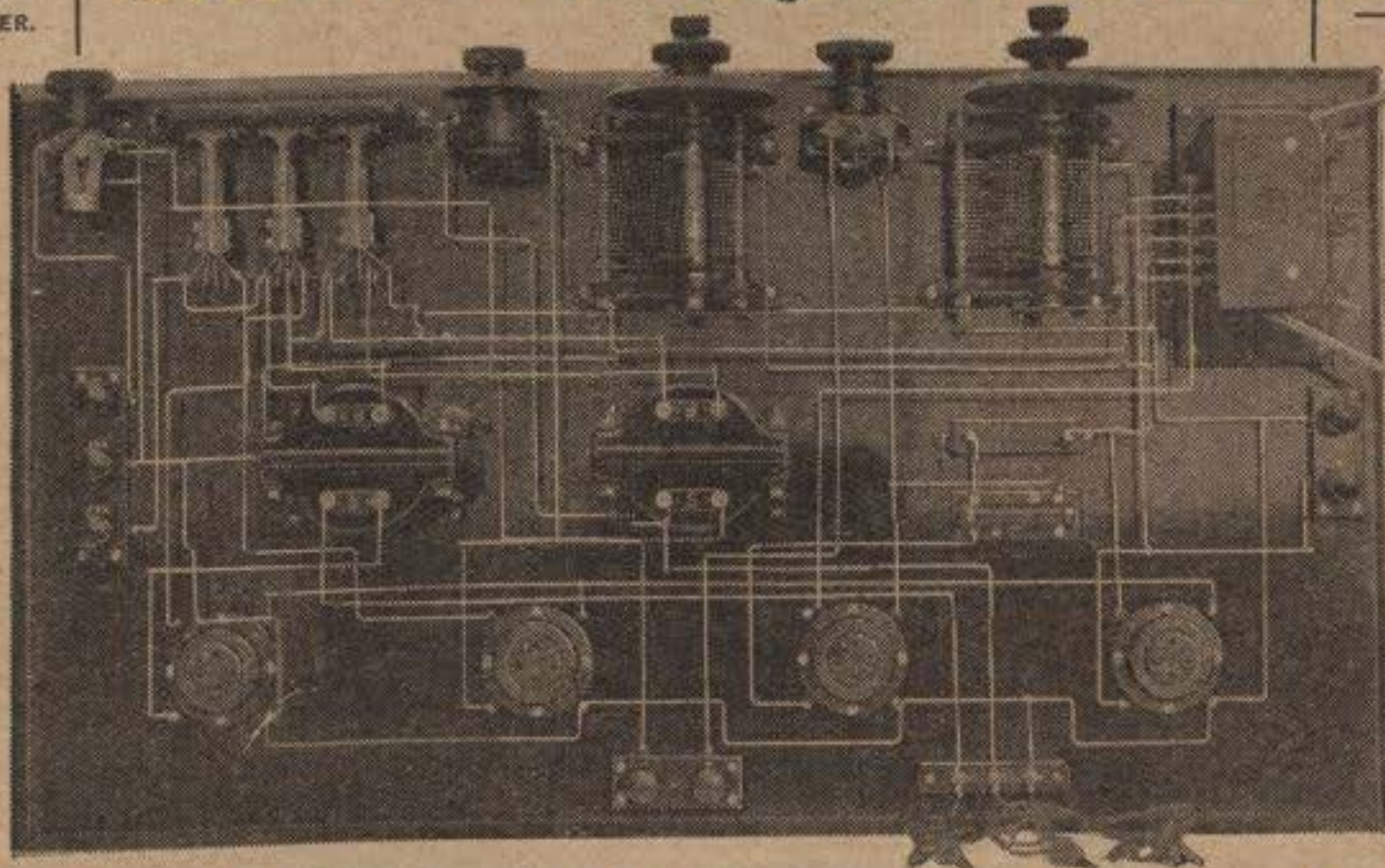

**STERLING**  
**CONDENSERS.**

Square Low Type with Verrier.

Straight fine tuning. Perfectly adjusted and gives delightfully smooth variation. Highest possible Maximum to Minimum ratio and suitable for low loss working.



.00025 mfd. ... 6/6  
.0005 " " ... 9/6  
.001 " " ... 10/6

**STERLING**  
**FIXED**  
**CONDENSERS.**



.001 to .0005 mfd. capacity.  
1/6 each.

**STERLING**  
**TELEPHONE PLUG**  
**AND JACK.**

For connecting radio telephones in circuit with any number of L.F. Amplifying Valves, if jacks are fitted in anode circuit of each stage.



Plug, 6/- Jack, 2/10.

**STERLING**  
**COIL**  
**HOLDERS**



Enables coarse and very fine tuning adjustment. Prices Double, 16/6; Triple (for mounting on either side of a panel), 20/-; Triple (mounted on base), 22/6.



resistances: 4.5 ohms and 30 ohms.

**STERLING**  
**Rotary Type**  
**Filament**  
**Resistance.**

4/8. Supplied in 2

This Receiver comprises one H.F. valve with tuned anode, a detector valve with reaction on anode of preceding valve, and two L.F. valves coupled by means of two Ideal Transformers to ensure purity and volume. Two, three or four valves may be used as desired.

**CIRCUIT DIAGRAM**

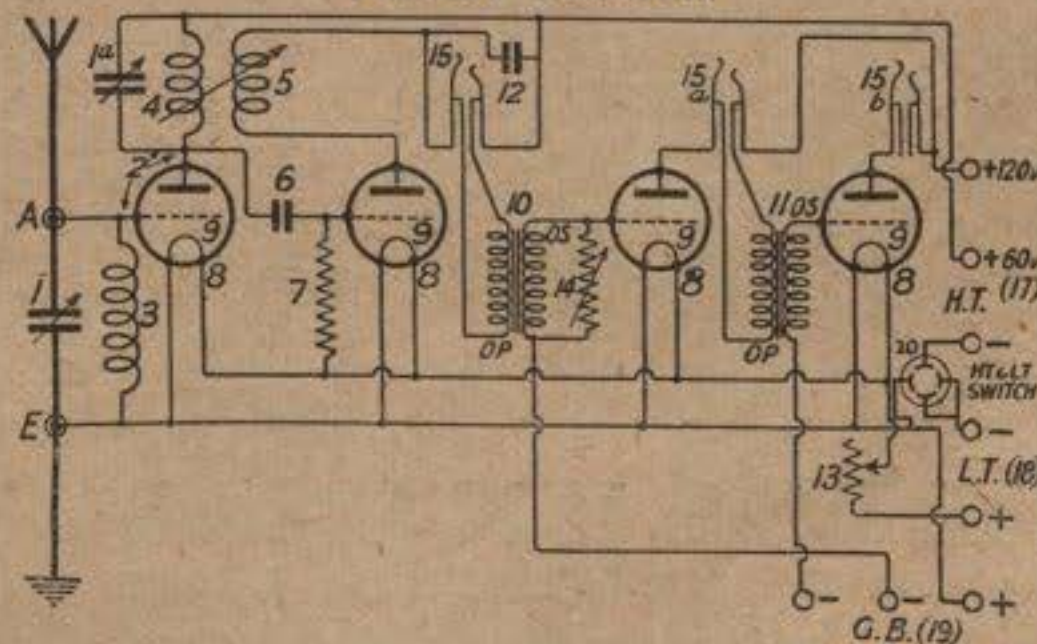

Constructional details and components required for the above and other Receivers, including a 7-valve Super Het., are given in Publication No. 446, "Circuits for Building Radio Receivers," sent on receipt of coupon.

**THE MARCONIPHONE COMPANY, LTD.**  
(Sole Agents for Sterling Telephone and Electric Company Ltd.)

Head Office:—  
210-212, Tottenham Court Road, London W.1.

Registered Office:—  
Marconi House, Strand, London, W.C.2.

To:—  
The  
**Marconiphone**  
**Company, Ltd.,**  
210-212, Tottenham  
Court Road, London,  
W.1.

Please send me, post free a copy of the Booklet, "CIRCUITS FOR BUILDING RADIO RECEIVERS."

Name.....

Address.....

RADIO TIMES

USE BLOCK LETTERS

Fill in Coupon and post in *id.* (unsealed) Envelope.

## SUGGESTIONS:



1. Build your own loud speaker and save money—full-size patterns and clear instructions are given with each LISSENOLA unit, showing how you can make this big, powerful horn of mellow tone for a few pence only. This can, if desired, be built into a freestanding or other cabinet—as shown on right.



2. You can buy this type of LISSENOLA Horn, 12in. Bore 13/6, 14in. Bore 17/6.

N.B.—We regret temporary shortage of this horn due to overwhelming demand. Delivery is being expedited. Please order from nearest dealer.



3. You can very easily make a cone or use a plated diaphragm and attach the LISSENOLA by means of the LISSENOLA Rod.



4. You can, in half a minute, change your gramophone sound box for a LISSENOLA unit, and have a cabinet loud speaker. No wiring, no screwing. Sound box instantly replaceable.

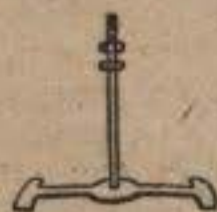

5. LISSENOLA Rod—the only thing required to adapt the LISSENOLA unit to carry a cone, paper plated, or any other similar diaphragm. Price 1/-.



## HISTORY REPEATS ITSELF

—Lissen Dealers besieged again this Christmas

**T**HOUSANDS of people were unable to obtain the Lissenola Loud Speaking Unit at Christmas, 1925, because of the record demand. Again this year shops were literally besieged for the Lissenola and its new assistant, the Lissenola Horn. Many disappointments were inevitable—we are sorry for these—but dealers' stocks of Lissenolas have been replenished and orders for the Lissenola Horn can now be executed rapidly.

What a reproducer the Lissenola is—what volume it delivers—what purity in the tones. It will not dither, it will not resonate even when used on 220 volts and more. It is the essential heart made to beat in every type of loud speaker. Some of its uses are shown on the left.

The remarkable efficiency and permanency of the delightful tone qualities and powerful reproduction of the LISSENOLA are largely due to the fine magnetic system, absolutely clean design and fine manufacturing for which LISSEN is renowned. The magnets themselves are made from rare metals and ores, alloyed by elaborate pyrometrically controlled heat treatments.

FIRST GET THE LISSENOLA—THEN ALL THESE THINGS CAN FOLLOW AS AND WHEN YOU WISH.

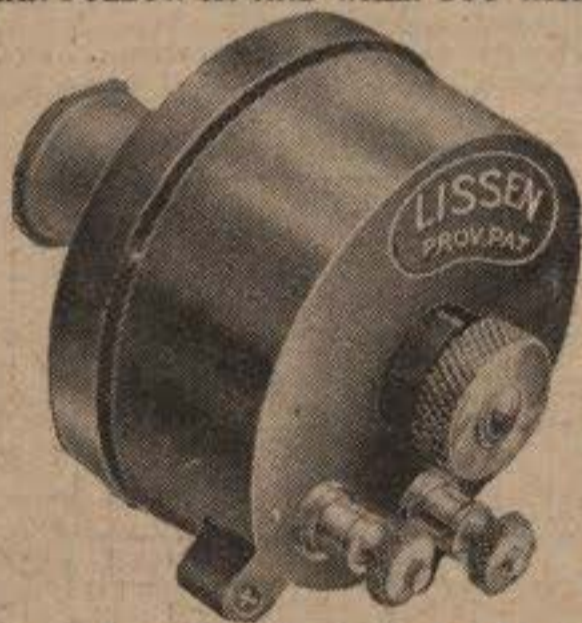

13'6

## LISSENOLA

LOUD SPEAKING UNIT

Made golden-toned for your enjoyment

BY CONCENTRATING UPON THE PRODUCTION OF ONE TYPE LISSEN GIVES YOU A SOUND REPRODUCING UNIT EQUAL TO ANY TO BE FOUND IN ANY LOUD SPEAKER COSTING UP TO £20.

Many worthless imitations—you can avoid all risk by asking for and insisting upon being given the LISSENOLA Loud Speaking Unit.

LISSEN LTD., 300-320, FRIARS LANE, RICHMOND, SURREY.

Managing Director: THOMAS N. COLE.

L. 197



Latest type of LISSENOLA HORN, 14in. Bore, big and powerful.

N.B.—Delivery from factory of this horn will begin on January 7th, 1927. Orders should be placed now with nearest dealer.

Also just introduced—a much appreciated stand to hold the LISSENOLA unit and the upright horn. Made inexpensive to give LISSENOLA users the opportunity of possessing it. Useful for home-built horns. 3/-

A complete loud speaker assembled from the LISSENOLA, the New Horn and New Stand is illustrated. Now the only full-size, full-powered, British-made Lissen quality loud speaker, and actual full-powered performance selling, to-day complete for 34/-.

# R.C. Sets are much the vogue —they have certain disadvantages, but this tells you HOW TO MAKE A RESISTANCE CAPACITY COUPLING UNIT COMPLETE IN 2 MINUTES FOR 5/6

**R**ESISTANCE capacity coupling (referred to as r.c. sets) using high impedance valves is popular at the moment. Booklets have been issued with instructions how to construct them. Unfortunately, these do not sufficiently stress the fact that to successfully build a good resistance capacity coupled set calls for some knowledge on the part of the builder and requires some care in the proper balancing of the circuit, if the proper volume without distortion is to be obtained. And they should emphasise also that the fixed condensers used should be absolutely leak-proof, otherwise 50 per cent. of volume will be lost. Users in any difficulty should ask their nearest LISSEN dealer.

If you are wanting to build a resistance capacity coupled set you will be glad to know that LISSEN can give you a resistance capacity unit in a most ingenious manner and at a low cost. In fact, if you already have the LISSEN Condenser and Resistances required all you need is the new LISSEN COMBINATOR (price 1/- only). This is entirely new and quite good. Into it fixed condensers and resistances of appropriate value can be clipped in a moment, and a complete resistance capacity coupling unit thus quickly formed. LISSEN HAS MADE THE INTERCHANGEABILITY OF VALUES SIMPLICITY ITSELF.

### IMPORTANT POINTS.

When the present largely used high impedance valves are used for r.c. coupled amplification it is of paramount importance that the fixed condenser you use should be absolutely leak proof, otherwise you will lose 50 per cent. of volume. LISSEN condensers are recommended because they deliver all their stored up energy—they never leak, they never vary. Again the resistance must be so good that in the anode circuit the resistance used must be capable of standing a big voltage without it being affected. That is, the grid circuit must not alter or vary in use —IT MUST BE SILENT.

Not only have LISSEN Resistances been tested by exposure to rain and sun on the factory roof (they are the same as the LISSEN Fixed Grid Leaks) and found to be unchangeable, but you can put a LISSEN Fixed Resistance of this type of 1 megohm value in a circuit connected straight on to a 220 volt main supply, and leave it in circuit indefinitely without any change taking place or noise developing in it. Such a test on a 1 megohm is equivalent to an 880 volt test on a Resistance of 2 megohms value. LISSEN Resistances of both these values stand the respective tests named.

### VALUES AND CAPACITIES.

We refer above to certain values and capacity in the resistances and condensers respectively. These will be found quite all right, but as so many booklets have been issued recently recommending various values, if you are building up a set in accordance with any such booklet, you can use the values and capacity therein recommended, but **TO SECURE FULL VOLUME AND NO DISTORTION IN R.C. COUPLED CIRCUITS YOU are strongly recommended to USE NONE OTHER THAN LISSEN FIXED CONDENSERS AND RESISTANCES.**

### Prices :

LISSEN COMBINATOR (this can be seen in illustrations holding the resistances and condenser, and shows how used end to end they will build up as desired) ..... 1/- each.

LISSEN FIXED CONDENSERS—accurate to within 5 per cent. of marked capacity—note the convenient case. .0001 to .001 1/- each (much reduced). .002 to .006 1/6 each (much reduced).

LISSEN FIXED RESISTANCES (called also Fixed Grid Leaks, same construction), all resistances. (Previously 1/- 1/8 each)..... each.

**ANY LISSEN DEALER WILL HELP YOU—he is a man with specialised knowledge in most cases. You will find a LISSEN dealer always courteous and obliging.**

**USE ANY CIRCUIT BUT ONLY LISSEN PARTS, NO MATTER WHAT ELSE MAY BE NAMED—you will eliminate distortion and gain in volume.**

*Lissen Gives You the Best Parts in Radio.*

**LISSEN LIMITED, 300-320, FRIARS LANE, RICHMOND, SURREY.**

Managing Director: THOMAS N. COLE.

L.101



1. Shows the LISSEN COMBINATOR with LISSEN Fixed Condenser and LISSEN Fixed Resistances linked up to form a complete r.c. coupling unit for H.F. or L.F. amplification. The condenser is a .002, the resistance on the right can be a grid leak resistance of 2 megohms, and the LISSEN Resistance on the left is the anode resistance, which can be 1 megohm.



2. Shows the LISSEN COMBINATOR with LISSEN Fixed Condenser and LISSEN Fixed Resistance for use as a tuned anode coupling. The condenser and the resistance should be connected up in the same way, too, for L.F. Choke Coupling (with a different value condenser) and similarly too, for use in conjunction with a 50,000 ohms anode resistance where relatively low (as opposed to high) impedance valves are used.



3. Shows the LISSEN COMBINATOR with condenser and grid leak connected in parallel as used for standard grid leak rectification. This does away with the need for soldering, although LISSEN also provides tags already tinned for those who want to solder.

# Do you use a 6 volt accumulator?

## B.T.H. HAVE NOW EVOLVED THE IDEAL VALVE COMBINATION

The famous B.4. Valve—the finest power amplifying valve ever made—has now its counterpart in the new B.4H. In these two valves we have provided the ideal combination for 6 volt accumulators.

The B.4H. is intended for H.F., detector and early L.F. stages and the B.4 for the final L.F. Stage.

Those who have had experience of the B.4 valve will find the B.4H. no less remarkable in its own sphere, while from the combination they will obtain a quality of reproduction hitherto undreamed of.

*If you have a B.4., buy a B.4H. If you haven't, buy both*

### B4H

Filament Volts ..... 6  
Filament Amps. .... 0.25  
H.T. Volts .... 60 to 120  
Impedance 28,000 ohms

**Price - 18/6**

### B4

Filament Volts ..... 6  
Filament Amps. .... 0.25  
H.T. Volts .... 40 to 120  
Impedance...6,000 ohms

**Price - 18/6**

# VALVES

The British Thomson-Houston Co. Ltd.

# A Real Advance in Battery Design for HIGH TENSION

## Exide TYPE WJ

### Some unique features

The ordinary type of accumulator plate loses its charge and becomes sulphated, so that its full capacity cannot be utilised, if the cells be left for any considerable time, especially if they are already partially run down.

This is exactly what a high tension battery has to put up with, so that the ordinary plate is obviously unable to do itself justice, and the problem demands a new and special type of cell not subject to sulphation or loss of charge when standing partially run down.

Exide High Tension Batteries, type WJ, comprise cells of new and special design specifically developed for this duty, which they fulfil with a degree of success which has surpassed the most sanguine hopes of their designers, is the admiration of the whole electrical industry, and has not been approached by any other make of battery.

Their plates are of a special nature, differentiating them entirely from all other types or makes.

They will stand for six months at least without detriment or loss of charge, even when partially run down, so that their full capacity is available though the discharge be spread over such periods. They can then be recharged, and, reasonably cared for, will last for years.

Their discharge is steady, free from fluctuations, and ensures pure reception against a silent background that is a revelation.

They provide the most satisfactory source of H.T. in existence, superior to any other H.T. battery, definitely superior to any battery eliminator, and infinitely superior to dry batteries, which give an uneven and noisy discharge, deteriorate rapidly, and then need complete renewal. In spite of their advanced design, their price is low, and they are cheaper than dry batteries in the long run.

**TYPE WJ**  
2,500 milli-amp. hrs.  
**15/-** per 20-volt unit.

**BEWARE OF IMITATIONS**  
Dry Batteries are out of date.

**TYPE WJ**  
2,500 milli-amp. hrs.  
**9d.** per volt.

# Exide

## THE LONG-LIFE BATTERY



The Sign of Skilled Service:

TYPE WJ  
20 Volts.



Registered Design No. 719181.

OBTAINABLE FROM ALL REPUTABLE DEALERS

# The WONDERFUL P.M. FILAMENT WITH THE HIGHEST FIGURE OF MERIT



## The filament figure of merit

is an accurate indication of what any filament gives in exchange for the correct applied input.

A comparison of figures of merit taken from a wide range of filaments shows the marked superiority of Mullard design. A study of the accompanying scale will indicate the vastly increased "output for input" possessed by Mullard P.M. Valves. This is due without question to the excellence of the Mullard P.M. Filament. Its generous emission of up to 5½ times that of an ordinary filament with its low current consumption of only one tenth ampere give it a remarkable performance of high efficiency.

To feel the rich reserve of power that is placed behind your rheostats when you fit Mullard P.M. Valves and to know that your accumulator charges can last up to 7 times as long as before is a pleasure and certainty for satisfaction that every radio amateur should lose no time in securing. Thousands have proved for themselves the manifold advantages of these valves with the wonderful Mullard P.M. Filament.

Make your radio a real success this season with Mullard P.M. Valves.

OBTAINABLE FROM ALL RADIO DEALERS

# Mullard

**THE · MASTER · VALVE**

For 4-volt accumulator or 3 dry cells	
THE P.M.3 (General Purpose)	0.1 amp. 14/-
THE P.M.4 (Power)	0.1 amp. 18/6
For 6-volt accumulator or 4 dry cells	
THE P.M.5 (General Purpose)	0.1 amp. 18/6
THE P.M.6 (Power)	0.1 amp. 18/6
For 2-volt accumulator	
THE P.M.1 H.F.	0.1 amp. 14/-
THE P.M.1 L.F.	0.1 amp. 14/-
THE P.M.2 (Power)	0.15 amp. 18/6



Evenly reproduces the whole harmonic scale

**H**ERE is a really magnificent Loud Speaker. One which gives the lie once and for all to the belief that a loud speaker's appearance is distasteful. It is the **Brown Disc Loud Speaker**. An instrument which sets new standards in design and in performance. In its handsome shape in either of four finishes—Black and Gold, Brown and Gold, Cream and Gold, and Oxydised Silver—the **Brown Disc** comes very near to perfection in Loud Speaker design. No one, in fact, would

deny that in appearance it is far ahead of all other Loud Speakers on the market. Few either would question the superiority of its performance. Pure, mellow tone. Adequate, undistorted volume. An even and true reproduction extending throughout the whole harmonic scale—a feature in which the Disc is unrivalled. The advance in Loud Speaker reproduction shown in the new **Brown** model can, however, only be appreciated by hearing it for yourself at your Dealer's. You'll be charmed with its appearance and will marvel at its tone. Brown and Gold Black and Gold Cream and Gold £7 7 0, Oxydised Silver Finish £8 8 0.

**S. G. BROWN, LTD., Western Avenue, North Acton, W3.**

Retail Showrooms: 19, Martineau Street, W.1; 15, Moorfields, Liverpool; 67, High Street, Southampton. Wholesale Depots: 2, Lindsays Place West, Bath; 120, Wellington Street, Glasgow; 5-7, Goshwin Street, Bradford; Cross House, Westgate Road, Newcastle; Howard S. Cooks & Co., 59, Caroline Street, Birmingham; Robert Gurney, Union Chambers, 1, Union St., Belfast, N. Ireland.



READ THESE  
OPINIONS  
FROM USERS  
OF THE  
R.C. THREESOME

"... I am truly astonished at the results. It is indeed all you claim for it. It is at present reproducing on a — Cone Loud Speaker which, as you are aware, requires considerable volume to work it efficiently..."  
W. J. B., Croydon.

"... it is an extremely fine circuit. There is absolutely no mush, and the musical instruments come through perfectly..."  
A. J. H., Farnworth.

"... I am delighted with it, the reception is really a treat..."  
R. H. B., Manchester.

"... my friends and myself are absolutely astounded at the results. 'Beautiful, mellow, natural reproduction, with an abundance of volume,' are the words of your advertisement and it cannot be emphasized too much..."  
H. J. R., Wolverhampton.

"... am delighted with it..."  
G. S. B., Richmond, Surrey.

"... I have now made the set, never having done anything of the sort before. It really is excellent, very clear and true... I picked up Newcastle and Swansea and some French station on the London coils, on 'phones (London closed), and I got Paris on Daventry coils quite loud on loudspeaker..."  
R. G. M., Tunbridge Wells.

"... The tone is absolutely real... This is a champion... It is a £20 set for half... BEST OF ALL..."  
T. R. H., Coventry.

"... entirely satisfactory and surpasses my expectations..."  
H. O. E., Brockley, London.

"... a wonderful set and simplicity itself in operation..."  
K. B., Ollerton.

## THIS REMARKABLE SET HAS DELIGHTED THOUSANDS THE R.C. THREESOME

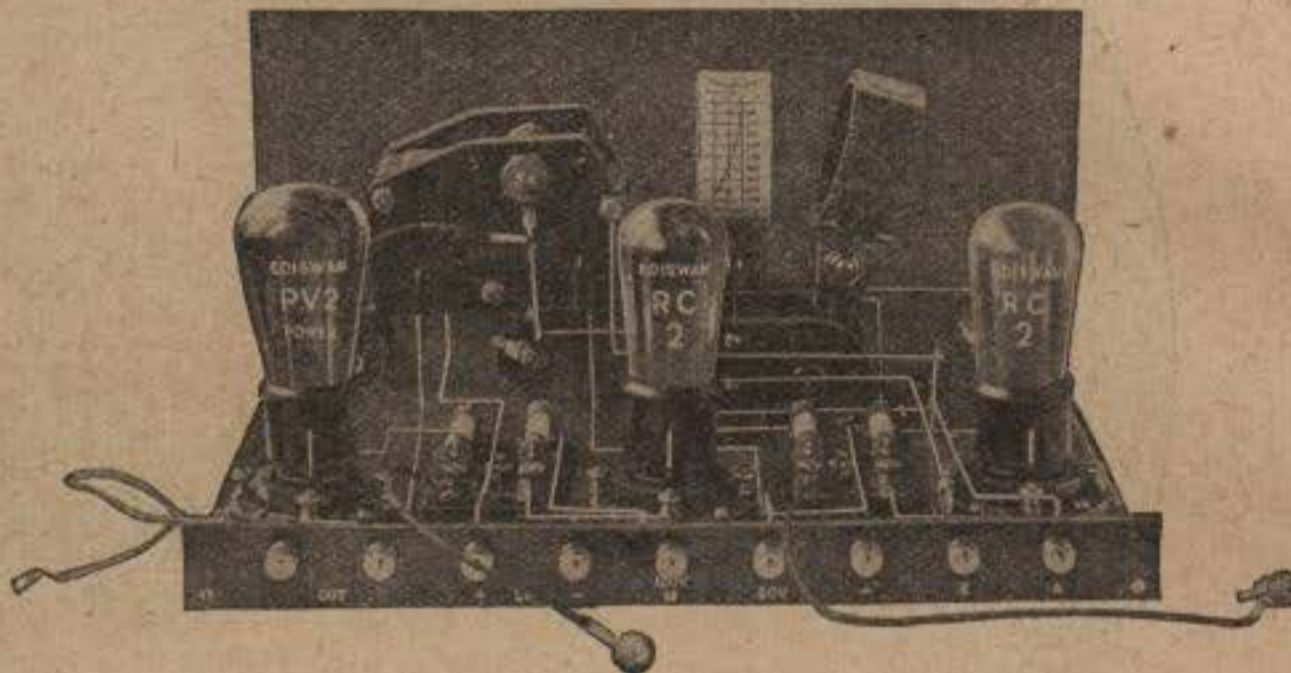

THE fine performance of the R.C. Threesome Resistance-Coupled Receiver has resulted in many glowing tributes being received.

Builders of this remarkable receiver now enjoy wireless reception of a standard hitherto unknown, yet the R.C. Threesome is so simple in design that it can be built in an evening.

Its tone is wonderfully mellow... its volume is abundant and free from blare and distortion. One dial control for both local station and Daventry reception.

The two new EDISWAN Valves—R.C.2. and P.V.2.—are the secret of the success of the R.C. Threesome.

Every user of valves should seriously consider the merits of the new EDISWAN Quarter-watt POINT ONE ECONOMY Valves, the types which have won the enthusiastic endorsement of the public. Ask your dealer about them.

### FREE BLUE-PRINT & INSTRUCTIONS

If you can use a screwdriver YOU can make this ultra-modern receiver. You can do it in an evening for £3, or less. The Instruction Book, is FREE, with BLUE PRINT.

**FILL IN COUPON—NOW!**

# EDISWAN

To THE EDISON SWAN ELECTRIC CO. Ltd.  
(Publicity) 123/5 QUEEN VICTORIA STREET, LONDON, E.C.4

Please send, post free, presentation copies of the "R.C. Threesome" Instruction Book and Blue-print.

Name .....

Address .....

PLEASE USE  
BLOCK LETTERS

RT. 14-1-27

V.17





7 p.m.



8 p.m.

## If your Accumulator has run down, don't lose heart—here is one you can fill with acid and use almost at once

SEVEN o'clock—and the accumulator run down! What is to be done? It is no use expecting to be able to buy a charged accumulator at such short notice, for everyone knows that a new accumulator requires a long slow charge to prepare it for use.

But stay! There is at last available an accumulator which only requires the addition of dilute acid to start it working. This wonderful new Accumulator is the Oldham O.V.D. It is the biggest boon ever offered to wireless enthusiasts. The long first charge is banished. Merely fill the O.V.D. with acid and in less than an hour it is ready for use.

The Oldham O.V.D. is different from all other accumulators. It has laminated plates [made under the Special Activation process] which permit the acid circulating thoroughly and acting upon the several surfaces simultaneously. The Oldham Laminode plate has two tremendous advantages which place it far ahead of competitors. It holds its charge over long periods and it can be charged rapidly without harm. These two advantages have never before been combined in any accumulator.

### A TIP WORTH REMEMBERING

Your accumulator may run down unexpectedly at a most awkward moment. Why not buy an O.V.D. and keep sufficient acid of the correct specific gravity in a small bottle for emergency use. Even if kept for years without acid the O.V.D. will not lose the initial charge it received at the factory.

Made only by  
**OLDHAM & SON, LTD.,**  
Denton, Manchester

London Office: 6, Eccleston Place, S.W. 1  
Glasgow Depot: 120, Wellington Street

The Oldham Laminode Plate is immensely strong—its stout girder-like construction [patent applied for] is proof against buckling whilst the elimination of separators and the freer circulation of the electrolyte prevents the charge leaking away when not in use. An Oldham O.V.D. will last a one-valve Dull Emitter Set at least 180 hours at a charge. Think of it—9 weeks broadcasting for a few coppers. Whilst a 2-valve Set owner will get 72 hours—almost a month's regular use.

And when the O.V.D. is exhausted it can be charged up rapidly within 8 hours instead of the customary 30 hours. Everyone has painful memories of accumulators ruined through careless charging. The Oldham O.V.D. is proof against such abuse. In fact, we ourselves have charged an O.V.D. fully within four hours without harm to the cell.

The new

Special Activation Process Batteries  
**OLDHAM**

O.V.D.

**5/6**

Capacity 10 amp hours

—the slow discharge Accumulator  
which can be fully charged in 8 hours

**5/6**

Capacity 10 amp hours

Gilbert Ad. 7056



Above:  
One of the Valves  
being picked up  
after its 500 feet  
drop.

Below: The "Wireless World" man hands the Valves to Pilot.

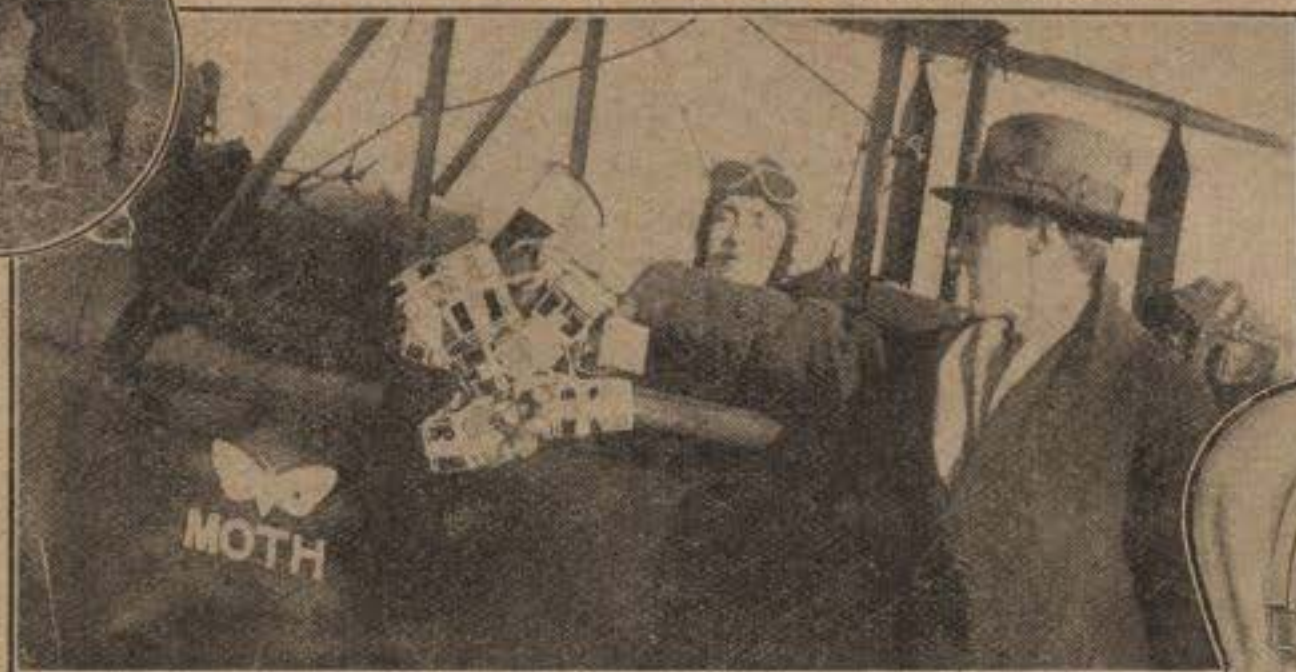

Below:  
A Stentor Two  
Valve used for  
this test.



## The most daring test ever conceived

—Cossor valves dropped from an aeroplane at 500 feet to prove toughness of filament

THERE took place on Monday, December 20th, 1926, the most astonishing test to which any wireless valves have ever been subjected. Twelve Cossor Valves were chosen at random from stock by editorial representatives from "Amateur Wireless," "Popular Wireless" and "Wireless World." These valves were numbered and packed in the ordinary cardboard carton without cotton wool, corrugated paper or other absorbent material. They were taken direct to Stag Lane Aerodrome and handed to Capt. Barnard, the pilot of a "Moth" aeroplane, with instructions to drop them overboard one at a time at a height of over 500 feet. The assistant Editor of "Amateur Wireless" accompanied the pilot.

Out of the 12 Cossor Power Valves which were thrown over-

board the following were the startling results:—

- 5 Valves were found to be in perfect condition (one landed on a corrugated iron roof and another on some wooden blocks).
- 5 Valves suffered from an internal derangement of the electrode system but the filaments were unharmed.
- 1 Valve was smashed to pieces through hitting the tail plane in flight (even in this case the filament was intact).
- 1 Valve fell out of range and was lost.

But in spite of the terrific drop and a 35 m.p.h. wind the filaments were intact in all valves.

This proves beyond question that the new Kalenised filament is the world's strongest filament. But only Cossor has the Kalenised filament—if you want long life, low current consumption and superb results see that your next valve is a Cossor.

Test carried out under supervision of  
"Amateur Wireless"  
"Popular Wireless"  
"Wireless World"

### TYPES & PRICES

#### Cossor Point One

210H for H.F. use ... 14/-  
210D for Detector ... 14/-  
(2 volts 1 ampere)

#### Cossor Power Valves

Stentor Two ... 18/6  
(2 volts 15 ampere)  
Stentor Four ... 18/6  
(4 volts 1 ampere)

All above Valves fitted with Cossor Kalenised Filaments

# Cossor —the Valve which serves you longest



**“He certainly sold us  
the right Loud Speaker”**

THAT is what you will probably say, and certainly think, after you have bought a B.T.H. C.2. Loud Speaker. It is right in tone, right in volume, right in appearance, and especially right in price.

It is a full-sized instrument, 24" high with a 14" flare, giving an *ample* volume of sound for any living room of average dimensions.

**TYPE  
C 2**

The *only*  
full sized  
full toned  
instrument  
for

**£3:0:0**

(This price does not  
apply in Irish Free  
State)



**LOUDSPEAKERS**

**BRITISH MADE**

2608 B

*The British Thomson-Houston Co., Ltd.*



# FELLOWS WIRELESS

**£6.15.0** COMPLETE AS BELOW  
or 38/4 down.

"Its volume is simply Great—in fact it equals many 3 and 4 valve sets I have heard (G.F.L., Netley Abbey.)"

One more tribute to the wonderful Little Giant Two. Little Giant Sets are made in 4 models and are supplied complete with all accessories including the famous Silver Clear Dull Emitter Louden Valves.

Specification.	Little Giant I.	Little Giant II.	Little Giant III.	Little Giant IV.
Receiver (including Marconi Royalty) .....	£2:2:6	£3:17:0	£4:12:0	£6:5:6
Louden 4-Volt D.E. Valves	(1) 8:0	(2) 16:0	(3) £1:4:0	(4) £1:12:0
H.T. Battery (Fellophone)	(54V) 6:3	(108V) 13:0	(108V) 13:0	(108V) 13:0
Fellows 4V. Accumulator ..	(20ah) 12:6	(20ah) 12:6	(20ah) 12:6	(40ah) 16:6
Aerial, Insulators, Wiring, Instructions .....	3:0	3:0	3:0	3:0
Headphones (H) or Junior Loud Speaker (LS) ....	(H) 11:6	(LS) 13:6	(LS) 13:6	(LS) 13:6
<b>Total Cash Price</b>	<b>£4:4:0</b>	<b>£6:15:0</b>	<b>£7:18:0</b>	<b>£10:3:6</b>
Deferred Payments. With Order .....	24:6	38:4	44:9	57:0
6 Monthly Payments of ..	12:3	19:3	22:5	28:8

**HOW TO OBTAIN THESE WONDERFUL SETS.**

- 1.—You can inspect and purchase Fellows apparatus at any of our branches (addresses given below).
- or 2.—You can forward the full cash value (in P.O., Money Order, or Cheque), direct to us or to our branches.
- or 3.—You can obtain your set on the Deferred Payment System by enclosing with your order the appropriate first instalment, as shown above, and forwarding direct to our Head Office.

Note.—All Fellows sets can be supplied on 7 days' trial, if full cash value is remitted. Money will be refunded in full if you are dissatisfied in any respect. They are sent packing free, carriage forward.

**FELLOWS, PARK ROYAL, N.W.10.**

*Branches:*

- LONDON: 20, Store St., Tottenham Court Rd., W.C. (Museum 9290).
- BIRMINGHAM: 248, Corporation Street (Central 435).
- BRIGHTON: 31, Queen's Road (Brighton 893).
- BRISTOL: 35, Narrow Lane Street (Bristol 7972).
- CARDIFF: Dominions Arcade, Queen Street (Cardiff 7685).
- LEEDS: 65, Park Lane (Leeds 21479).
- MANCHESTER: 33, John Dalton Street (Central 1164).
- NEWCASTLE: 36, Grey Street (City 980).
- NOTTINGHAM: 30, Bridlesmith Gate (Nottingham 5551).
- TONBRIDGE: 34, Quarry Hill (Tonbridge 172).

Write for 48-pp. Illustrated Catalogue No. 10 FREE

**BUY DIRECT AND SAVE MONEY**

M.C. 289.

# Louden Valves

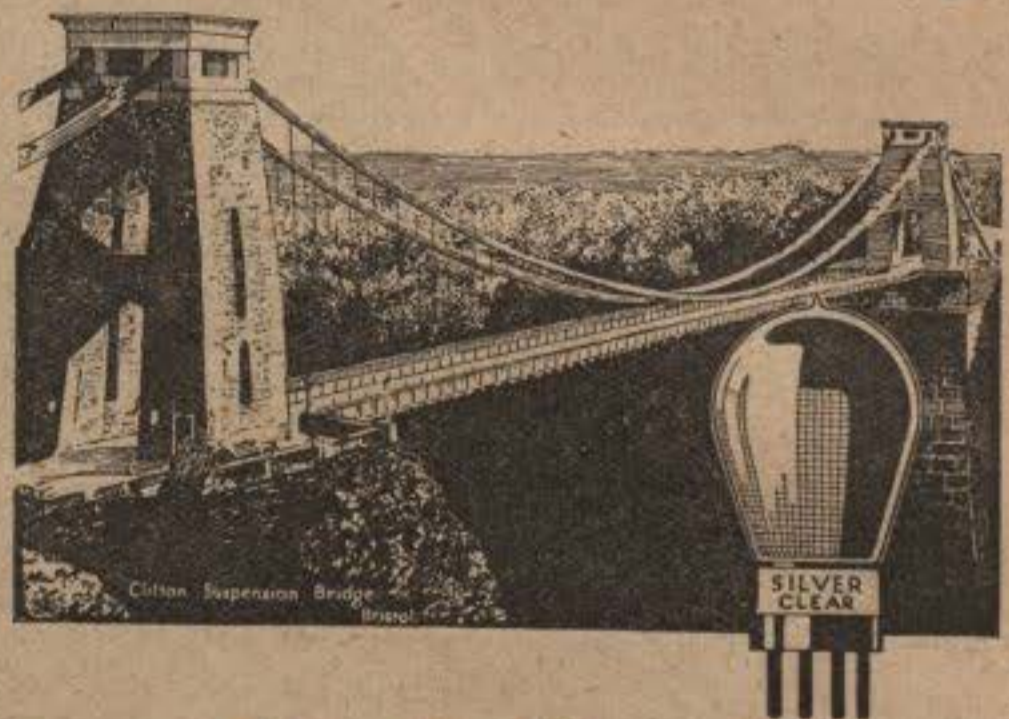

"..... for purity of tone and minimum of current your valves appear to be the best on the market."

You want a valve that costs little and gives you a long life of silver clear tones using the very minimum of current to do it.

More and more people each day are discovering all these properties combined in the Loudon Valve. Then like Mr. Jeves, they write and say so.

"Dear Sirs,  
I thank you for sending me the two 6 Volt Dull Emitter Valves: I have tried them out on my set, and obtained exceptionally good reception.  
Without disparaging other well advertised makes (which I have tried) I can assure you that for purity of tone and for minimum of current your valves appear to me to be the best on the market.  
You can make any use of this deserved and unsolicited testimonial you care to.  
Yours Truly,  
C. JEVES (Bristol)."

Louden Valves are made by British labour in a British factory with British capital and can be depended upon for the finest volume, range and silver clearness. They can only be offered at such low prices because of our well-known policy of selling direct to the public and cutting out the middleman's profits. The list below gives prices and full particulars. Order your Loudon Valves from us by post.

<b>4/6</b> Bright Emitters. L.F. Amplifier. F.1. H.F. Amplifier. F.2. Detector. F.3. 5.5 volts 0.4 amps.	<b>8/-</b> Dull Emitters. L.F. Amplifier. L.E.R.1. H.F. Amplifier. L.E.R.2. Detector. L.E.R.3. 2 volts 0.2 amps.	<b>8/-</b> Dull Emitters. L.F. Amplifier. F.E.R.1. H.F. Amplifier. F.E.R.2. Detector. F.E.R.3. 4 volts 0.1 amps.
<b>9/-</b> Dull Emitters. L.F. Amplifier. F.E.R.1. H.F. Amplifier. F.E.R.2. Detector. F.E.R.3. 6 volts 0.1 amps.	<b>11/-</b> D.E. Power Valves. Transformer Amplifiers P.E.R.1. Resistance Amplifiers P.E.R.2. 4 volts 0.2 amps.	<b>12/-</b> D.E. Power Valves. Transformer Amplifiers P.E.R.1. Resistance Amplifiers P.E.R.2. 6 volts 0.2 amps.

Postage and Packing: 1 Valve, 4d. 2 or 3 Valves, 6d. 4, 5 or 6 Valves, 9d.

**FELLOWS, PARK ROYAL, N.W.10.**

*Branches:*

- LONDON: 20, Store St., Tottenham Court Rd., W.C. (Museum 9290).
- BIRMINGHAM: 248, Corporation Street (Central 435).
- BRIGHTON: 31, Queen's Road (Brighton 893).
- BRISTOL: 35, Narrow Lane Street (Bristol 7972).
- CARDIFF: Dominions Arcade, Queen Street (Cardiff 7685).
- LEEDS: 65, Park Lane (Leeds 21479).
- MANCHESTER: 33, John Dalton Street (Central 1164).
- NEWCASTLE: 36, Grey Street (City 980).
- NOTTINGHAM: 30, Bridlesmith Gate (Nottingham 5551).
- TONBRIDGE: 34, Quarry Hill (Tonbridge 172).

WRITE FOR 48-pp. ILLUSTRATED CATALOGUE No. 10 FREE

**BUY DIRECT AND SAVE MONEY**

M.C. 100.

# FELLOWS WIRELESS

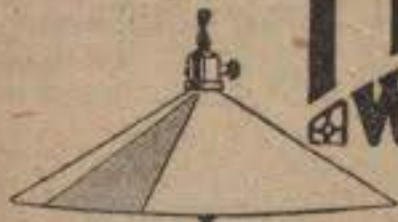

For 4 or 6 volt Accumulators **45/-**  
 For H.T. Accumulators **50/-**

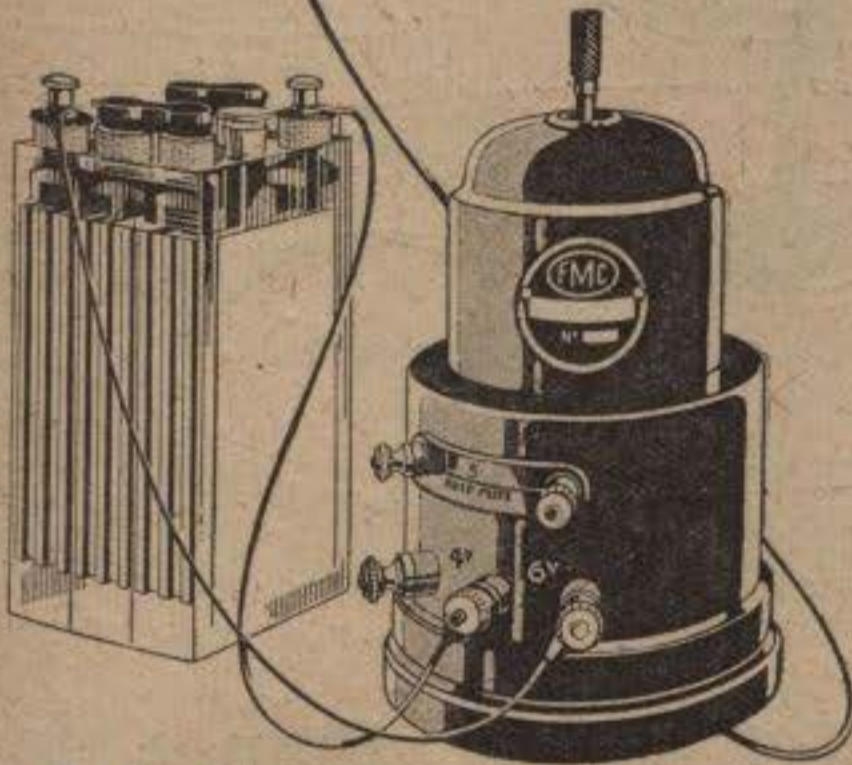

## 10 hours for 1d.!

If you have Alternating Current (A.C.) Electric Light you can charge your Accumulator at home for an absurdly low cost by using the Fellow's Accumulator Charger.

This charger is simplicity itself, there are no expensive parts to require renewal, it cannot harm your electric light in any way, and it is as safe to handle as your loud speaker.

Simply plug it into an electric lamp holder (see above), switch on, give a twist to the knurled knob, and, when the little motor is running connect up your 4 or 6 volt accumulator and leave it on charge until the bubbles rise freely in the acid inside. The charger will automatically give the correct charging current.

You need only have one accumulator because you can charge it up when your set is not in use.

Your present accumulators probably cost from 9d. to 1/6 per charge; you cannot be certain that they get fair treatment while away: and there are frequently delays and disappointments.

The Fellow's charger eliminates all these troubles. It will charge up a large accumulator (e.g. 6V. 30 ah) for a cost of about ONE PENNY for 10 hours, even in districts where lighting is as high as 5d. per unit.

There is also a special model designed to charge up H.T. Accumulators in batches of 60 volts at a time. Output 1/2 ampere.

You can, by remitting full cash value, have one of these chargers on SEVEN DAYS' FREE TRIAL. If you are not more than satisfied we will take it back and return your money in full.

*N.B. When ordering please state carefully voltage and frequency (cycles) of your mains. You will find this information on your meter.*

**FELLOWS, PARK ROYAL, N.W.10.**

Branches:

LONDON: 23, Store St., Tottenham Court Rd., W.C.1. (Museum 9200).  
 BIRMINGHAM: 248, Corporation Street (Central 435).  
 BRIGHTON: 31, Queen's Road, (Brighton 599).  
 BRISTOL: 36, Narrow Wine Street (Bristol 7972).  
 CARDIFF: Dominions Arcade, Queen Street (Cardiff 7685).  
 LEEDS: 65, Park Lane (Leeds 21479).  
 MANCHESTER: 33, John Dalton Street (Central 1164).  
 NEWCASTLE: 36, Grey Street (City 980).  
 NOTTINGHAM: 30, Bridlesmith Gate (Nottingham 5551).  
 TONBRIDGE: 3, Quayside (Tonbridge 172).

Write for  
 48-pp.  
 Illustrated  
 CATALOGUE  
 No. 10  
 FREE

**BUY DIRECT AND SAVE MONEY**

M.C. 269.

## IMPORTANT NOTICE WIRELESS VALVES.

### *Injunction and Damages.*

ON the 9th December, 1926, in the High Court of Justice Chancery Division in the case of Marconi's Wireless Telegraph Company Limited against Midland Valves Limited the Defendants having paid agreed sums for damages and costs amounting to £75 consented to an order for an Injunction restraining them from infringing Letters Patent 184446 and for delivery up to the Plaintiffs of all '06 Ampere Valves in their possession or power.

## WARNING to DEALERS and USERS.

NOTICE IS HEREBY GIVEN by Marconi's Wireless Telegraph Company Limited, both on their own behalf and on behalf of the British Thomson-Houston Company Limited and the General Electric Company Limited, that legal proceedings will be taken against any Company, firm or person selling or using valves which infringe any patents owned or controlled by them.

[M.W. 035.1



## Omelettes and Optimism

Quality, in an omelette, depends upon what comes out of the eggshells. You get no more out of a battery than the maker puts inside it. Stuffing counts.

When you see "P. & R." outside a battery, you know that inside it's crammed full of *energy*. Get a P. & R. and you get capacity—real, valve-working capacity, not somebody's cheerful optimism in amp-hours: you get a battery which stands up to its work: you get the kind of battery which Rolls-Royce fits as standard equipment.

You get, too, a "Dagenite" case which is leak-, shock-, acid- and heat-proof: anti-splash and anti-spray vents: terminals protected from corrosion by petroleum glands: you get a BATTERY. And one which costs no more than the ordinary kind.

**P AND R**  
**PETO & RADFORD**  
**ACCUMULATORS**  
*The beginning and the end in*  
**POWER**

1.0



# FELLOWS WIRELESS

**Better value than this  
 simply does not exist.**

**THE VOLUTONE - 45/-**

*(Carriage forward)*

A really handsome full size loud speaker, giving rich, natural reproduction sufficient to fill a large room. It stands 20 inches high, has an adjustment for controlling volume, and makes a fitting addition to the most expensive set.

**THE JUNIOR - - 13/6**

*(Carriage forward)*

is now offered in an improved form, 19 inches high, adjustable diaphragm, for 13/6 (carriage forward). It will fill any ordinary sized room with clear, sweet tones, and being designed throughout by experts, it will give results with which no loud speaker assembled at home from parts can hope to compare.

**FELLOWS HEADPHONES - 11/6**

*(Postage 6d.)*

complete with cords, weigh only 6 ounces. They are sensitive to the weakest speech and music, are extremely comfortable, and being made of Duralumin, they will neither rust nor tarnish.

*All goods are sent on 7 days' free trial and your money is willingly refunded if you are not completely satisfied.*

**SEND YOUR ORDER NOW.**

**FELLOWS, PARK ROYAL, N.W.10.**

*Branches:*

LONDON: 20, Store St., Tottenham Court Rd., W.C. (Museum 9209).  
 BIRMINGHAM: 248, Corporation Street (Central 435).  
 BRIGHTON: 31, Queen's Road (Brighton 899).  
 BRISTOL: 36, Narrow Wine Street (Bristol 7972).  
 CARDIFF: Dominion Arcade, Queen Street (Cardiff 7685).  
 LEEDS: 65, Park Lane (Leeds 21479).  
 MANCHESTER: 33, John Dalton Street (Central 1164).  
 NEWCASTLE: 35, Grey Street (City 960).  
 NOTTINGHAM: 30, Bridlesmith Gate (Nottingham 5551).  
 TONBRIDGE: 34, Quarry Hill (Tonbridge 172).

WRITE FOR  
 48-pp.  
 ILLUSTRATED  
 CATALOGUE  
 No. 19  
 FREE.

**BUY DIRECT AND SAVE MONEY**

M.C. 283.

**BROADCASTS BY 'TONE' & 'POWER'**  
*The Boon' Companions of Osram Valves*



**'TONE' & 'POWER'**  
**in the Family Circle**

Father brought TONE and POWER home with him the other evening.

The kiddies simply loved POWER, they'd never heard jazz music so loudly. So did Brother Bert. He revelled in the range of distant stations. Mother and Father, in their more sedate way, appreciated TONE'S influence in the delicate musical phrases of the Symphony and the richness of the bass tones.

It will be a long time before our genial friends leave that family circle. They're indispensable to the evening's enjoyment every night. Bring POWER and TONE into your home by buying—

**Osram Valves**

for TONE & POWER

The G.E.C.—  
 your guarantee



Adol. of The General Electric Co., Ltd., Magnet House, Kingsway, London, W.C.2.

**FELLOWS WIRELESS**

Type B. Unit for  
 Alternating Current  
 £4 : 10 : 0

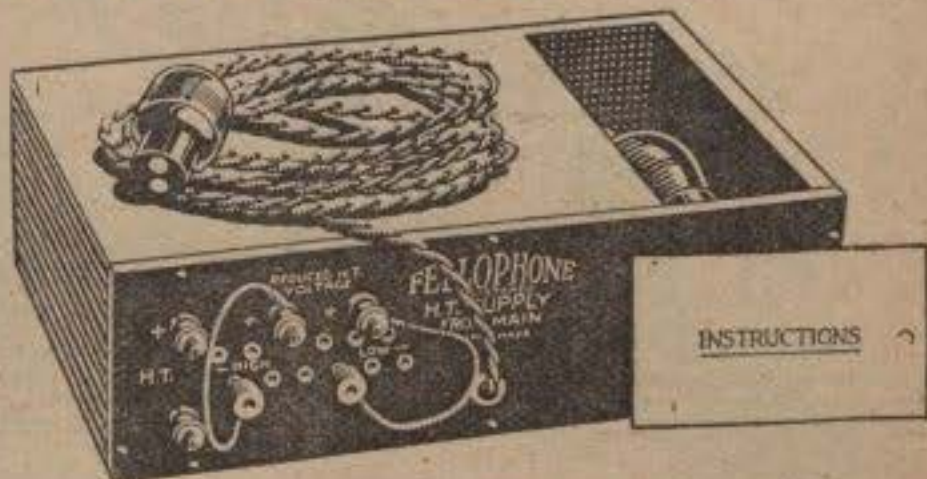

**HIGH TENSION FROM YOUR ELECTRIC LIGHT**

If you have Electric Light, send for a Fellophone H.T. Mains Unit and do away with the expense of renewing exhausted Batteries.

All you have to do is to plug the adaptor of the Mains Unit into a lamp holder, switch on, and an inexhaustible supply of H.T. current is at your disposal.

Fellophone Mains Units possess, among others, the following advantages.

1. **ABSOLUTE SAFETY.** An ample margin of safety is provided in these Units which completely safeguards them against breakdown. They are as safe to fit as an electric light globe and as safe to handle when working as an H.T. Battery.
2. **LOW COST.** The current consumed by these Units is no more than that taken by a "night light" electric lamp. They are thus extremely economical and they rapidly save the cost of renewing Batteries.
3. **PERFECT RECEPTION.** When ordering state the voltage of your lighting mains and (if current is alternating) the frequency. Your Mains Unit will then give you perfect reception free from all "ripple" or "hum."
4. **A.C. or D.C.** Fellows Mains Units are made either for Alternating Current or Direct Current and for all voltages commonly in use for lighting.
5. **SINGLE OR MULTI VOLTAGE.** These units, whether for A.C. or D.C., are made in two TYPES. Type A. delivers a single value only of H.T. Voltage. Type B. delivers three separate values, two of which are variable over twelve tapings, thus enabling the exact required voltages to be applied to several valves at once. (For further description see pages 28 and 29 of our Catalogue No. 10.)
6. **SEVEN DAYS' FREE TRIAL.** You can have a Fellows Mains Unit on seven days' trial by remitting full value. If you are not more than pleased with it, return it to us in good condition and we will promptly refund your full remittance.

PRICES (Carriage forward):

A.C.	D.C.
Type A. (50 volts) - £3 : 10 : 0	Type A. (50 volts) - £2 : 10 : 0
Type A. (100 volts) - £3 : 10 : 0	Type A. (70 volts) - £2 : 10 : 0
Type B. (multi voltage) £4 : 10 : 0	Type A. (100 volts) - £2 : 10 : 0
	Type B. (multi voltage) £3 : 10 : 0

**FELLOWS, PARK ROYAL, N.W.10.**

Branches:

- LONDON: 20, Store St., Tottenham Court Rd., W.C. (Museum 8200).
- BIRMINGHAM: 248, Corporation Street (Central 435).
- BRIGHTON: 31, Queen's Road (Brighton 899).
- BRISTOL: 36, Narrow Wine Street (Bristol 7972).
- CARDIFF: Dominions Arcade, Queen Street (Cardiff 7685).
- LEEDS: 65, Park Lane (Leeds 21479).
- MANCHESTER: 33, John Dalton Street (Central 1164).
- NEWCASTLE: 36, Grey Street (City 980).
- NOTTINGHAM: 30, Bridlesmith Gate (Nottingham 5951).
- TONBRIDGE: 34, Quarry Hill (Tonbridge 172).

Write for 48pp.  
 Illustrated  
 Catalogue No. 10  
 FREE.

**BUY DIRECT AND SAVE MONEY**



**D**ing dong bell,  
Anyone can tell,  
Mum's made BISTO gravy,  
What a lovely smell!

**BISTO**  
THE  
GRAVY MAKER

N.R. 26-A



**1927 CALLING**

Loudly and insistently to every Wireless man wanting finest results at lowest prices:— Resolve that this year you buy none but the All-British super-economy Lustrolux Valves. Resolve further, that all broken and burnt-out valves be sent for treatment by the

**"LUSTROLUX VALVE REPAIR SERVICE."**

Charges are half list prices or under. Write for particulars.

Whether H.F., L.F., or Power Valve, there's a Lustrolux for your needs, 2, 3, 4, or 6 volt; '06 amp. to '34 amp.

2 volt to 4 volt range  
H.F. & L.F. 9/- each.

2 volt to 6 volt range  
Power Valves,  
15/- each.

Ask your dealer or send direct.

**LUSTROLUX**  
LTD.,  
West Bollington, near Macclesfield.

Send for Catalogue "K."



*To your Set  
Fit and Forget*

**THE "WAVELENGTH"**

**6" 6"**



**PERMANENT DETECTOR**  
THE COMPLETE UNIT WHICH IS INCOMPARABLE FOR EFFICIENCY

**FULLY GUARANTEED**

The "Wavelength" is the world's finest Detector Unit and gives best reception

**£100 Comprehensive Insurance Policy FREE!**

*Insist on the "Wavelength"*

Stocked by  
**Woolworth's Stores, Boots Cash Chemists, and all Dealers.**

MANUFACTURED BY  
J.M.O. LTO., 170, GARRETT LANE, LONDON, S.W.18.

**for 14/- down**  
**a 6ft RILEY**  
**Home Billiard Table**  
delivered  
in your home



**WHY NOT BILLIARDS AT HOME?**

Install a Riley "Home" Billiard Table. It will last a lifetime and provide enjoyment out of all proportion to its cost. Send a P.O. to-night for 14/- and Rileys will dispatch the popular 6ft. size "Home" Billiard Table complete and ready for play. The balance you pay monthly as you play.

Other sizes are as follows:

4ft. 4in. x 2 ft. 4in.	£7 0 0
5ft. 4in. x 2 ft. 10in.	£9 0 0
6ft. 4in. x 3 ft. 4in.	£11 15 0
7ft. 4in. x 3 ft. 10in.	£15 0 0
8ft. 4in. x 4 ft. 4in.	£21 10 0

Or in 18 Monthly Payments of 8/6, 11/-, 14/-, 18/-, or 26/- respectively.

Rileys have another table for the home—the **COMBINE BILLIARD AND DINING TABLE**. Can be had in various designs and sizes, and in Oak or Mahogany. Prices range from £23 10 0. Cash or Easy Payments.

**E. J. RILEY, LTD.,**  
Raymond Works, Accrington.  
And Dept. 17, 147, Aldersgate Street,  
London, E.C.1.

Write for **FREE PRICE LIST.**

7 days free trial given

Riley's "Home" Billiard Table shown resting on an ordinary dining table. It is not a toy, but a perfect billiard table. Riley's pay the carriage and take all risk in transit. All accessories are included, and

Details—Riley's Full Size Tables Repairs and Accessories sent free.

**CLARKE'S "ATLAS"**



**H.T. BATTERY ELIMINATOR**

Makes the old H.T. Battery an unnecessary evil for all who have electric light in the home.

With a supply of 100 to 230 volts any voltage of high tension from 20 to 150 can be obtained by simply plugging-in to the nearest electric light socket. Four stages of Grid Bias are provided for: 4, 8, 12, and 16 volts. Current consumption negligible.

For **DIRECT** and **ALTERNATING** Current. **FULL WAVE RECTIFICATION.**

Direct Current Model for 200/250 volt mains	£4 10 0
Alternating Current Model for 100/125 volt mains and 200/250 volt mains (including 2 valves)	£8 5 0
Royalty on A.C. Model only, 12/6 per instrument.	
Model D.C.6. (Direct Current) gives 40, 60, 90, 120 volts (No Grid Bias)	£3 5 0

Sole Manufacturers: Each instrument carries the "Atlas" guarantee.  
**H. CLARKE & CO. (Manchester) LTD.,** Atlas Works, Old Trafford, Manchester.



Get a Good  
Loud Speaker!

**J**UST as it pays to get a good pair of shoes, a good hat and good clothes, so does it pay to get a good loud speaker. It will last, it will look well always, it will give enduring satisfaction and though it may cost a little more in initial outlay it will prove to be an economical investment in the long run. Good loud speakers, moreover, are not necessarily expensive—the world famous AMPLION is obtainable in 21 different varieties at prices ranging from 38/- to thirteen guineas.



**Radiolux  
AMPLION**

"For Better Radio Reproduction"

Announcement of Graham Amplion, Limited, 25 Savile Row, London, W.1.



**JOHN HENRY  
CALLING!** in the  
JANUARY N<sup>o</sup>. of the  
**AMPLION  
RADIO MAGAZINE**

also  
**PETER DAWSON  
H. M. BATEMAN**

"How to Get the Best out of Your Receiver"  
(No. 1 of an interesting new series)

"Limitations in Wireless Reception" (Colin H. Gardner)  
**FREE RADIO TIME CHART** (British & Continental)

**FREE COMPETITION** with Numerous Prizes

"Children's Corner"—and numerous attractions.

Your Newsagent has it or will get it for you

PUBLISHERS:

**GRAHAM AMPLION LIMITED**  
25-26, Savile Row, London, W.1.

**6<sup>d</sup>**



**FELLOWS  
WIRELESS**

**60 volts**

now **7/6!!**

*This 60-volt H.T. Battery  
tapped every 3 volts and  
complete with wander plugs  
now costs only 7/6 (post free).*

Once again Fellows show the way to lower prices. First Valves, then Sets, then Loudspeakers, and now H.T. Batteries!

Can you find anywhere such value in H.T. Batteries as this all-British 60-volt Fellows?

In a short time the sale of these H.T. Batteries has risen to *thousands* a week and so once again we are passing on to you the benefit of the savings effected.

Order from our Branches or direct by post from us to-night.

<b>54 Volts</b>	with lead for grid bias .....	post free	<b>6/6</b>
<b>60</b>	"	tapped every 3 volts and supplied complete with wander plugs .....	<b>7/6</b>
<b>108</b>	"	tapped every 6 volts and supplied complete with wander plugs.....	<b>13/-</b>

**FELLOWS, PARK ROYAL, N.W.10.**

Branches:

LONDON: 20, Store St., Tottenham Court Rd., W.C. (Museum 9200).  
BIRMINGHAM: 248, Corporation Street (Central 435).  
BRIGHTON: 31, Queen's Road (Brighton 899).  
BRISTOL: 36, Narrow Wine Street (Bristol 7972).  
CARDIFF: Dominions Arcade, Queen Street (Cardiff 7685).  
LEEDS: 65, Park Lane (Leeds 21475).  
MANCHESTER: 33, John Dalton Street (Central 1164).  
NEWCASTLE: 36, Grey Street (City 980).  
NOTTINGHAM: 30, Bridlesmith Gate (Nottingham 5551).  
TONBRIDGE: 34, Quarry Hill (Tonbridge 172).

Write for 48-pp.  
Illustrated  
Catalogue No. 10  
FREE.

**BUY DIRECT AND SAVE MONEY**

# FELLOWS

## ELECTRIC LAMPS

FROM 1/2



**LAMPS THAT LAST**

*They last!*

because of the infinite care taken in their manufacture.

TYPE B (Half-Watt Type).			
Voltages and Prices.			
Watts.	30 V.	50 V.	100, 110, 200, 230, 250
30	..	1/10	..
40	..	1/10	1/10
60	2/-	2/-	2/-
100	..	..	2/10
200	..	..	6/-

TYPE A (Vacuum Type).			
Voltages and Prices.			
Watts.	50 V.	100 V. or 110 V.	200, 210, 220, 230, 240, 250
10	1/2	..	..
20	1/2	..	..
30	..	1/2	1/4
60	..	1/2	1/4

Postage and packing: 1 and 2 lamps, 6d., 3, 4, 5 or 6 lamps, 9d.

N.B.—Kindly state the type, watts, and exact voltage, as shown on your electric light meter, of the lamps you require. Include with your remittance amount to cover postage as shown above. Remember every Fellows Lamp is guaranteed.

## BUY BY POST & SAVE MONEY

FELLOWS, PARK ROYAL, N.W.10. M.C.L.2.

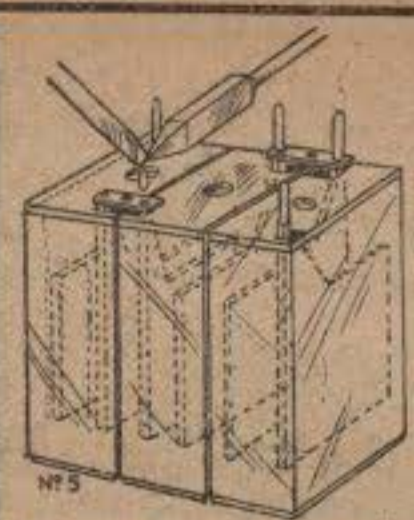

# 6 1/2d. Per Volt

Capacity:  
3,000 Milli-Ampere hours

## WHY PAY DOUBLE-

the price for your H.T. Accumulator when you can easily assemble your own at home in a couple of hours of Champion H.T. ACCUMULATOR PARTS at 6 1/2d. per complete volt?

CHAMPION H.T. ACCUMULATOR PARTS are guaranteed, made of best quality all British material; they have stood the severest tests, and have a 20% higher capacity than many other well-known makes at nearly double the price.

It is a recognised fact that a 40-50 volt H.T. Accumulator is equivalent in power to a 60-66 volt H.T. dry Battery; then why not begin by making a 40 volt H.T. Accumulator?—and should you still wish for more power you simply add more cells at will (you get full power all the time; not 60 volts to-day, run down to 50 volts next week, as is the case with your dry Battery). Recharge once every 7-8 months. Your Grid Bias Battery, too, for best results should be made of Champion H.T. Parts.

**Parts required for each 2 volt cell.**

- 1 Champion Glass Jar, with separator .. 4d. each
- 1 Champion Positive Plate, and bridge in sealed packet .. 4d. each
- 1 Champion Negative Plate, in sealed packet .. 4d. each
- Champion Mica Glass Jar covers (1 for each jar), packet of 12 .. 3d.
- Champion Accumulator Pitch, per packet, enough for whole Acc. .. 3d.

Each article can be obtained separately, or in quantities at the rate of 6 1/2d. per complete volt, of all Leading Dealers; or post free direct from the manufacturers. When ordering direct please send correct money to avoid delay. Cheques, M.O. and Postal Orders should be crossed. Illustrations and full instructions with every Battery or free on application.

Carrier Free—With every 40 or 60 cells of Champion H.T. Accumulator Parts a Wooden Carrier to fit same will be given free.

**THE CHAMPION ACCUMULATOR CO., 2, Prebend Street, Leicester.**

# SAXON GUIDE TO WIRELESS

If you wish to make wireless instruments which are unbeatable in price, quality or EFFICIENCY, this is the book you must have.

Everything about wireless is so clearly explained that any beginner can make the most efficient sets obtainable.

**FULL INSTRUCTIONS WITH CLEAR WIRING DIAGRAMS**

are given for making COMPLETE CRYSTAL SETS, SINGLE VALVE SETS, ONE AND TWO VALVE AMPLIFIERS, DUAL AMPLIFICATION SETS, TWO, THREE AND FOUR VALVE TUNED ANODE ALL-WAVE RECEIVERS; ALSO THE VERY LATEST FIVE VALVE RESISTANCE CAPACITY RECEIVER. The exact cost of each set is clearly stated.

The chapter on testing wireless components is alone worth the price of the book.

**NO SOLDERING.  
NO DRILLING.  
NO KNOWLEDGE REQUIRED.**

**176 PAGES**  
Price 1/3 post free.

**SPECIAL APPROVAL OFFER.**

This book will be sent on approval on receipt of your promise to remit 1/3 or return the book within seven days.

SAXON RADIO CO. (Dept. 20), SOUTH SHORE, BLACKPOOL.

## Valves Repaired - AS GOOD AS NEW!!

(except Waco, Low-Capacity, and 4-Electrode Types).

**HALF PRICE**

Minimum D.E. current 0.15 amps. when repaired.

**ALL BRIGHT AND DULL EMITTERS LISTED AT LESS THAN 10/- MINIMUM CHARGE 5/-**

TRANSMITTING VALVES REPAIRED

Up to 3 Valves, Cheapest method is by letter post. Remittance should be enclosed with valves. Phone—Wimbledon 051.

**VALCO LTD. (DEPT. R.T.), TABOR GROVE, WIMBLEDON, LONDON, S.W.19**

CONTRACTORS TO H.M. GOVERNMENT.

# PERFEX AERIALS

**IMPROVE RECEPTION BEYOND CONCEPTION—ASK USERS.**



WIRELESS APPARATUS, LTD., 35, PANTON ST., HAYMARKET, LONDON, S.W.1

## Learn to Play JAZZ!

If you can play the Piano, you, too, can become a real dance Pianist!

### Billy Mayerl

the world's greatest syncopated pianist and radio favourite, will teach you through the post by his wonderful new method. Easy—rapid—fascinating! Hundreds already successful. Write now for FREE book and full particulars.

**BILLY MAYERL SCHOOL (Dept. R), 29, Oxford Street, London, W.1.**



## play Bagatelle at home



*On a perfect bagatelle table — not a toy.*

7/9 DOWN secures the popular 6ft. size. The balance you pay in 17 monthly payments of 7/6. Cash Price £6-10-0

Bagatelle played at home with your family and friends is a wonderfully entertaining game for winter nights. Every home can now have its own bagatelle table. Riley's Easy-way-to-play makes this possible. There are three sizes, 6ft., 7ft., and 8ft.; suitable for the smallest rooms. Can be folded and stored away. All accessories included. CARRIAGE PAID. Free packing case. 7 days' free trial and Riley's takes all risk in transit. Full Price List free on request.

**E. J. RILEY, LTD. JASPER WORKS, ACORINGTON, and (Dept. 34) 147, Aldersgate Street, London, E.C.1.**

## EVERY LOUDSPEAKER DESERVES MULLARD MASTER VALVES

—Ask for—  
Mullard P.M. Power Valves.

## "EKCO" H.T. UNITS

### SCRAP DRY BATTERIES!

by obtaining H.T. Current from electric supply mains (D.C. & A.C.) by just attaching Adapter to electric light lampholder!

**SAFE! SILENT! SOUND!**

The "QUALITY" Unit.  
UNITS TO SUIT } from 42/6.  
ALL SETS }  
ILLUSTRATED FOLDER FREE!



E.K. COLE LTD (Dept. H.) 513, London Rd., Westcliff-on-Sea.

*Player's  
please!*



**100**

**PLAYER'S "MEDIUM"  
NAVY CUT CIGARETTES**

**4/8**

**A Gift  
that gives a  
Hundred Happy Memories**

ALSO PACKED IN 10's, 20's AND 50's

NCC 5

## The fighting spirit in a Battery—

**A**T the end of a long programme if you look back through the hours you will recall that never once during that time was there any sagging in your loud speaker reproduction if you use the LISSEN New Process Battery.

Sustained tones, no peaks, no depressions, but a smooth power flow all the time which has kept your loud speaker natural in its utterance and fresh-voiced till the end.

You know that your LISSEN battery is absolutely fresh when you get it, too, because, due to our new direct to dealer policy of distribution it has gone straight into dealers' shops from factory. You benefit also because this cuts out all wholesale profits, and you get a battery which would otherwise have been higher priced.

Rated at 60 volts the LISSEN New Process Battery goes considerably over. It is full of live yet silent cells, packed with pure energy, and offering a stubborn resistance to the drain imposed by long programmes.

If you want to improve your loud speaker reproduction, this fine battery will help you.

Ask for it next time. Say "LISSEN New Process." Take nothing else. If any difficulty you can send direct to factory, but please mention dealer's name and address.

**H**ear your LISSENOLA working off this battery to know what a good loud-speaker and a good battery can do together.

The New Process by which this battery is made is known to and exclusive only to LISSEN.

LISSEN LIMITED,  
300-320, FRIARS LANE,  
RICHMOND, SURREY.

Managing Director: Thomas N. Cole.



(Price would have been 13/- but for new policy.)

L. 105